



Equipment Catalog

Crimpers, Hose Saws, Test Benches,
Accessories, Dies & Replacement Parts

Table of Contents

CRIMPERS

PC100S-RCD Portable Series Crimper.....	4
PC100P-RCD Portable Series Crimper.....	6
PC100H-RCD Portable Series Crimper.....	8
PC125M-RCD Portable Series Crimper.....	10
PC125-RCD Series Crimper.....	12
PC125PS (Positive Stop) Series Crimper.....	14
PC150 Standard Series Crimpers.....	16
PC150 Double Angle Series Crimpers.....	18
PC150HD Series Crimper.....	20
PC200M Series Crimper.....	22

CONTINENTAL'S SHOP IN A BOX

Continental Introduces the New Shop In A Box.....	24
PC125-RCD Shop In A Box.....	26
PC150-2 Shop In A Box.....	28
PC150HD Shop In A Box.....	30
PC200i Shop In A Box.....	32

CRIMPERS WITH CRIMPIQ™ CONTROLLER

Continental Introduces the New CrimpIQ™ Controller.....	34
PC200i Series with CrimpIQ™ Controller.....	36
PC440i Series with CrimpIQ™ Controller.....	38
PC600i Series with CrimpIQ™ Controller.....	40
PC1000i Series with CrimpIQ™ Controller.....	42
PC1200i Series with CrimpIQ™ Controller.....	44

HOSE SAWS

HS-150 Series Hose Saw.....	46
HS-500 Series Hose Saw.....	48

SM300 / SM300M HOSE SKIVERS

SM300 Electric Hose Skiver Unit.....	50
SM300M Hand Operated Hose Skiver Tool.....	52

TEST BENCHES

PCTB "PLC" Series Test Benches.....	54
PCTB "Manual" Series Test Benches.....	56

CC-FP10 FITTING PUSHER

CC-FP10 Series Fitting Pusher.....	58
------------------------------------	----

HOSE REEL RACKS

Hose Reel Rack 24" & 36" Wide Series.....	60
---	----

PNEUMATIC TRAPEZE

Pneumatic Trapeze Series.....	62
-------------------------------	----

CLASSIC CRIMPERS

PC125M Series.....	64
PC125 Series.....	65

THE NEW CRIMPIQ™ CONTROLLER RETRO-FIT KIT

CrimpIQ™ Controller Retro-Fit Kit for PC200/PC400 Series....	66
--	----

CONTINENTAL CALIPERS

Bluetooth/Standard/Notched Calipers.....	68
--	----

CRIMPER REPLACEMENT KITS

PC125RCD/PC125/PC150/PC150H/PC150HD PC200/PC400 Series.....	69
--	----

Table of Contents

DIES SERIES

PC125 Dies.....	70
PC125RCD Dies.....	70
PC150 Dies.....	71
PC150 Double Angle Dies.....	71
PC150H Dies.....	72
PC200 Dies.....	72
PC600i Dies.....	73
PC1000i Dies.....	73
PC1200i Dies.....	74
PC125-AC Dies.....	75
PC125RCD-AC Dies.....	75
PC150-AC Dies.....	75
PC150H-AC Dies.....	75
PC200-AC Dies.....	75

PC150H & PC200 DIE SERIES DECALS

PC150H & PC200 Die Series Decals.....	76
PC150H & PC200 Die Series Die Decals Kit.....	76

REPLACEMENT PARTS

Removable Pushers.....	77
Pressure Plates.....	77
T420 Pressure Plates.....	77
Compression Rings.....	77
Die Storage Shelves/Racks.....	78
Die Lubricant.....	78

Die Removal Tools.....	79
Foot Switches.....	79
Adjustable Coupling Stops & Manual/Electric Back Stops.....	79
PSW101 Spacer Rings.....	79
Micrometers.....	80
Protective Master Die Foam Pads.....	80
Die Springs/Screws.....	80
Die Lock Studs.....	80
Master Die Lock Studs.....	81
Hose Saw Blades & Accessories.....	81
SM300 / SM300M ID & OD Skiving Tools.....	81
CrimpIQ™ Controller & Accessories.....	82
Hand/Pneumatic/Electric Pumps.....	82

ELECTRICAL PLUG CONFIGURATION

Electrical Plug Configurations.....	83
-------------------------------------	----

PREVENTATIVE MAINTENANCE PACKAGE

PC200/400/440/600/600L/1000 Series Crimpers.....	84
--	----

CRIMPER CALIBRATION SERVICE

Crimping Equipment.....	85
-------------------------	----

PC100S-RCD Portable Series Crimper

CAPABILITY

- (-16) B2 Fittings
- (-08) SG Fittings

TECHNICAL DATA

- **CRIMPING FORCE** 35 Ton
- **WEIGHT** 48 lbs. (crimper only)
- **DIMENSIONS** 12-½" L x 12-½" W x 21-½" H
- **DIE SERIES** PC125RCD



SAP #	Pump	PSI	Reservoir Capacity	Country Approved	Dies Included	Die Sizes (MM)	Quick Disconnect Included	Shelf Included
21063190	Pneumatic	10,000	100 cu in (1,639 cc)	Any	(7)	12, 16, 19, 23, 27, 31, 43	✓	✓
21063169	Hand	10,000	25 in ³ (410 cc)	Any	(7)	12, 16, 19, 23, 27, 31, 43	✓	✓

EQUIPMENT



Crimpers

PC100S-RCD Portable Series

PC100S-RCD Portable Series Crimper

The PC100S-RCD crimper can be carried to the jobsite with a handle and support stand, making this crimper ideal for portable crimping requirements. Whether carried on-site, used in a vehicle or even stationary at the shop, the PC100S-RCD is designed as a low volume crimper for occasional use. The crimp diameter is set and controlled with an easy-to-read T420 micrometer. This affordable crimper is packaged in component parts to fit the needs of the user.

The PC100S-RCD standard package includes: T420 micrometer, LED light indicator, removable pusher, standard pressure plate, Continental digital caliper, die removal magnet, and CRIMPX die lubricant oil w/ dauber cap.

PC100S-RCD Features

NOTCHED PRESSURE PLATE

- Ideal when crimping 90 deg. fittings



Lightweight portable crimper can be carried to almost any location where service is required



Micrometer is fully adjustable for a precise crimp



Easy Lubrication Maintenance



Crimper position can be adjusted for optimum crimping position



Open design allows the operator to accurately position the fitting prior to crimping



LED indicator light will turn on to indicate that the crimp is complete

PC100P-RCD Portable Series Crimper

CAPABILITY

- (-16) B2 Fittings
- (-08) SG Fittings

TECHNICAL DATA

- **CRIMPING FORCE** 35 Ton
- **WEIGHT** 66 lbs. (crimper only)
95 lbs. (crimper w/ case)
- **DIMENSIONS** 16" L x 16" W x 14-¼" H (crimper only)
16" L x 16" W x 18" H (crimper inside case)
- **DIE SERIES** PC125RCD



SAP #	Pump	PSI	Reservoir Capacity	Country Approved	Dies Included	Die Sizes (MM)	Carrying Case Included
21063168	Pneumatic	10,000	100 cu in (1,639 cc)	Any	(7)	12, 16, 19, 23, 27, 31, 43	✓

PC100P-RCD Portable Series Crimper

The PC100P-RCD crimper can be transported easily to the jobsite, making this crimper ideal for portable crimping requirements. Whether transported on-site, used in a vehicle or even stationary at the shop, the PC100P-RCD is designed as a low volume crimper for occasional use. The crimp diameter is set and controlled with an easy-to-read T420 micrometer. This affordable crimper is packaged in component parts to fit the needs of the user.

The PC100P-RCD standard package includes: T420 micrometer, LED light indicator, removable pusher, standard pressure plate, Continental digital caliper, die removal magnet, and CRIMPX die lubricant oil w/ dauber cap.

PC100P-RCD Features

COMPACT ENGINEERED DESIGN

- Ideal for small workshops
- Convenient storage case to keep the crimper and crimping accessories all together
- The unit can be easily transported in vehicles for on-site jobs



Lightweight portable crimper with a convenient storage case



Crimper and crimping accessories can be stored in the case

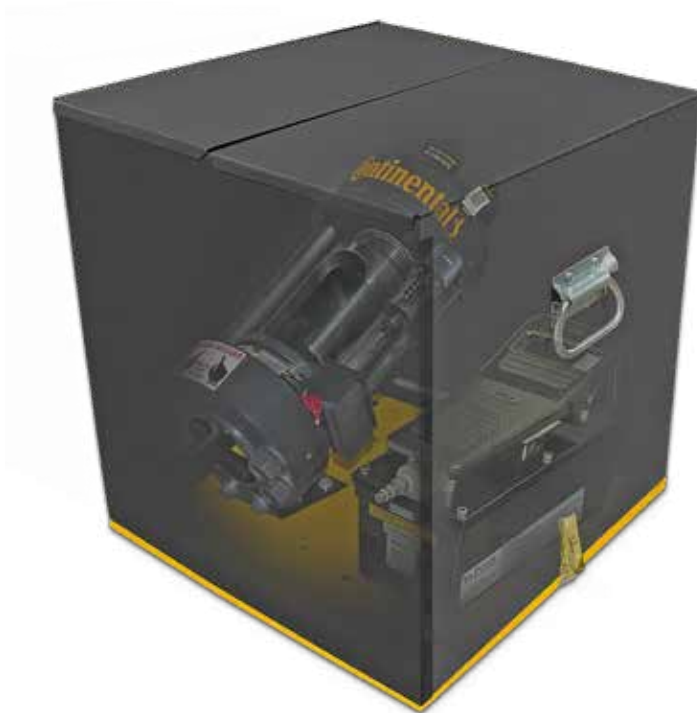

Micrometer is fully adjustable for a precise crimp



Easy Lubrication Maintenance

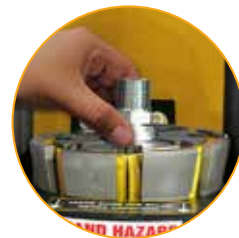

Open design allows the operator to accurately position the fitting prior to crimping



LED indicator light will turn on to indicate that the crimp is complete

PC100H-RCD Portable Series Crimper

CAPABILITY

- (-16) B2 Fittings
- (-08) SG Fittings

TECHNICAL DATA

- **CRIMPING FORCE** 35 Ton
- **WEIGHT** 66 lbs. (crimper only)
95 lbs. (crimper w/ case)
- **DIMENSIONS** 16" L x 16" W x 14-¼" H (crimper only)
16" L x 16" W x 18" H (crimper inside case)
- **DIE SERIES** PC125RCD



SAP #	Pump	PSI	Reservoir Capacity	Country Approved	Dies Included	Die Sizes (MM)	Carrying Case Included
21063167	Hand	10,000	25 in ³ (410 cc)	Any	(7)	12, 16, 19, 23, 27, 31, 43	✓

EQUIPMENT



Crimpers

PC100H-RCD Portable Series

PC100H-RCD Portable Series Crimper

The PC100H-RCD crimper can be transported easily to the jobsite, making this crimper ideal for portable crimping requirements. Whether transported on-site, used in a vehicle or even stationary at the shop, the PC100H-RCD is designed as a low volume crimper for occasional use. The crimp diameter is set and controlled with an easy-to-read T420 micrometer. This affordable crimper is packaged in component parts to fit the needs of the user. The PC100H-RCD standard package includes: T420 micrometer, LED light indicator, removable pusher, standard pressure plate, Continental digital caliper, die removal magnet, and CRIMPX die lubricant oil w/ dauber cap.

PC100H-RCD Features

COMPACT ENGINEERED DESIGN

- Ideal for small workshops
- Convenient storage case to keep the crimper and crimping accessories all together
- The unit can be easily transported in vehicles for on-site jobs



Lightweight portable crimper with a convenient storage case



Crimper and crimping accessories can be stored in the case



Micrometer is fully adjustable for a precise crimp



Easy Lubrication Maintenance

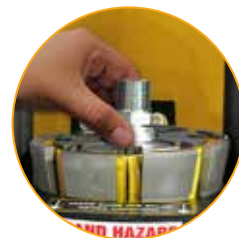

Open design allows the operator to accurately position the fitting prior to crimping



LED indicator light will turn on to indicate that the crimp is complete

PC125M-RCD Portable Series Crimper

CAPABILITY

- (-20) B2 Fittings
- (-16) SG Fittings



TECHNICAL DATA

- **CRIMPING FORCE** 60 Ton
- **WEIGHT** 85 lbs. (crimper only)
- **DIMENSIONS** 17" L x 10-1/4" W x 18-1/2" H
- **DIE SERIES** PC125RCD



SAP #	Pump	PSI	Reservoir Capacity	Country Approved	Dies Included	Die Sizes (MM)	Quick Disconnect Included	Drawer/Stand Included
20821205	*None	N/A	N/A	Any	(8)	16, 19, 23, 27, 31, 34, 43, 50	✓	✓
20821206	*None	N/A	N/A	Any	(5)	16, 19, 23, 31, 41	✓	✓
20821204	*None	N/A	N/A	Any	None		✓	

*Do not forget to buy your pump that best fits your portable crimping requirements. See the chart below.

SAP #	Pump	PSI	Reservoir Capacity	Country Approved	Pump Model
20244931	Hand	10,000	43 in ³ (705 cc)	Any	
20244932	Pneumatic	10,000	100 cu in (1,639 cc)	Any	
20244916	110V / 3/4HP	10,000	1 Gallon	U.S.A	

PC125M-RCD Portable Series Crimper

The PC125M-RCD crimper can be carried to the jobsite with a handle and support stand, making this crimper ideal for portable crimping requirements. Whether carried on-site, used in a vehicle or even stationary at the shop, the PC125M-RCD is designed as a low volume crimper for occasional use. The crimp diameter is set and controlled with an easy-to-read T420 micrometer. This affordable crimper is packaged in component parts to fit the needs of the user.

The PC125M-RCD standard package includes: T420 micrometer, adjustable retraction stop, LED light indicator, removable pusher, standard pressure plate, notched pressure plate, Continental digital caliper, die removal magnet, and CRIMPX die lubricant oil w/ dauber cap.

PC125M-RCD Features

ADJUSTABLE RETRACTION STOP

- Limits ram retraction to only the amount required to remove the hose and coupling
- Saving time on multiple repetitive crimps



Portable rugged steel frame and strain rods provide strength, stability, and performance for all crimping service



Micrometer is fully adjustable for a precise crimp



Easy Lubrication Maintenance



Ideal notched pressure plate when crimping 90 deg. fittings



Open design allows the operator to accurately position the fitting prior to crimping



LED indicator light will turn on to indicate that the crimp is complete

PC125-RCD Series Crimper

CAPABILITY

- (-20) B2 Fittings
- (-16) SG Fittings

TECHNICAL DATA

- **CRIMPING FORCE** 60 Ton
- **WEIGHT** 154 lbs. (crimper only)
- **DIMENSIONS** 22-½" L x 13" W x 22-½" H
- **DIE SERIES** PC125RCD
- **OIL CAPACITY** 1 gal.



SAP #	Voltage	Phase	Plug	Hertz	Country Approved	Dies Included	Die Sizes (MM)	Stand Drawer Included
20809573	110V	1	NEMA 5-15	60	U.S.A	(8)	16, 19, 23, 27, 31, 34, 43, 50	✓
20969061	220V	1	NEMA 6-20	60	U.S.A	(8)	16, 19, 23, 27, 31, 34, 43, 50	✓
20809574	110V	1	NEMA 5-15	60	Canada	(8)	16, 19, 23, 27, 31, 34, 43, 50	✓
20833029	110V	1	NEMA 5-15	60	U.S.A	(5)	16, 19, 23, 31, 41	✓
20888688	110V	1	NEMA 5-15	60	Canada	(5)	16, 19, 23, 31, 41	
20809571	110V	1	NEMA 5-15	60	U.S.A	None		
20809572	110V	1	NEMA 5-15	60	Canada	None		
20913958	12VDC	1	Jumper Cables	N/A	Any	None		

EQUIPMENT



Crimpers

PC125-RCD Series

PC125-RCD Series Crimper

The PC125-RCD crimper with its open design, removable pusher and easy-to-use, rubber-cage die set, is designed for higher production volume and repetitive use. Crimp diameter is set and controlled with an easy-to-read T420 micrometer. The PC125-RCD is packaged for shop service.

The PC125-RCD standard package includes: T420 micrometer, electronic stop switch, adjustable retraction stop, removable pusher, standard pressure plate, notched pressure plate, adjustable coupling stop, pneumatic start/stop pendant switch, Continental digital caliper, die removal magnet, and CRIMPX die lubricant oil w/ dauber cap.

PC125-RCD Features

PC125 STAND/DRAWER

- The PC125-RCD crimper can be mounted on the PC125 Stand/Drawer
- PC125-RCD dies and crimping tooling can be stored in the drawer



Micrometer is fully adjustable for a precise crimp



Easy Lubrication Maintenance



Ideal notched pressure plate when crimping 90 deg. fittings



Retraction Stop limits ram retraction for quick repetitive crimps



Coupling Stop makes repetitive crimps faster



Electronic Stop Switch shuts the pump off when the crimp cycle is complete

PC125PS (Positive Stop) Series Crimper

CAPABILITY

- (-16) B2 Fittings

Compatible only with the following hose:
SR1SN, SR2SN, SR/XR/ARC16SC, SCP3,
XCP3, FPII, SR/AR12 and HR4

TECHNICAL DATA

- **CRIMPING FORCE** 60 Ton
- **WEIGHT** 150 lbs. (crimper only)
- **DIMENSIONS** 22-½" L x 13" W x 22-½" H
- **DIE SERIES** PC125RCD
- **OIL CAPACITY** 1 gal.



SAP #	Voltage	Phase	Plug	Hertz	Country Approved	Dies Included	Die Sizes (Inches)	Spacers Included	Spacers Sizes (Inches)
20871410	110V	1	NEMA 5-15	60	U.S.A	(8)	.650, .785, .930, 1.120, 1.260, 1.410, 1.610, 1.680	(11)	.085, .110, .130, .145, .160, .175, .190, .220, .250, .300, .400
20888687	220V	1	NEMA 6-20	60	Canada	(8)	.650, .785, .930, 1.120, 1.260, 1.410, 1.610, 1.680	(11)	.085, .110, .130, .145, .160, .175, .190, .220, .250, .300, .400
20815352	110V	1	NEMA 5-15	60	U.S.A	None		None	

EQUIPMENT



Crimpers

PC125PS Series

PC125PS (Positive Stop) Series Crimper

The PC125PS is a Positive Stop crimper capable of crimping 2-wire braid hose and 4-wire spiral hose up through 1" ID. The crimp diameter is controlled through the use of specific die and spacer combinations. The PC125PS is packaged for shop service.

The PC125PS standard package includes: Adjustable retraction stop, removable pusher, standard psw pressure plate, (psw notched pressure plate only for SAP# 20871410), adjustable coupling stop, pneumatic start/stop pendant switch, Continental digital caliper, die removal magnet, and CRIMPX die lubricant oil w/ dauber cap.

PC125PS Features

PC125PS TOOLING

- Easy to use crimping tooling
- Only requires specific die and spacer within specifications to crimp the hose assembly



Crimp diameter is controlled by specific die and spacer combinations



Easy Lubrication Maintenance

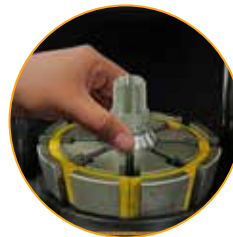

Open design allows the operator to accurately position the fitting prior to crimping



Ideal notched pressure plate when crimping 90 deg. fittings



Retraction Stop limits ram retraction for quick repetitive crimps



Crimper can be mounted on the PC125 Stand/Drawer dies & crimping tools can be stored

PC150 Standard Series Crimper

CAPABILITY

- (1-½") B2 Fittings
- (1-¼") SG Fittings

TECHNICAL DATA

- **CRIMPING FORCE** 80 Ton
- **WEIGHT** 305 lbs. (crimper only)
- **DIMENSIONS** 32" L x 17" W x 29" H
- **DIE SERIES** PC150 Standard
- **OIL CAPACITY** 1 gal.



SAP #	Voltage	Phase	Plug	Hertz	Country Approved	Dies Included	Die Sizes (MM)	Die Shelf Included
20244967	110V	1	NEMA 5-15	60	U.S.A	(9)	16, 19, 23, 27, 31, 34, 41, 50, 56	✓
20244966	220V	1	NEMA 6-20	60	U.S.A	(9)	16, 19, 23, 27, 31, 34, 41, 50, 56	✓
20298225	110V	1	NEMA 5-15	60	Canada	(9)	16, 19, 23, 27, 31, 34, 41, 50, 56	✓
20298226	220V	1	NEMA 5-15	60	Canada	(9)	16, 19, 23, 27, 31, 34, 41, 50, 56	✓
21082113	12VDC	1	Jumper Cables	N/A	Any	(9)	16, 19, 23, 27, 31, 34, 41, 50, 56	✓
20244941	110V	1	NEMA 5-15	60	U.S.A	None		
20244942	220V	1	NEMA 6-20	60	U.S.A	None		
20298223	110V	1	NEMA 5-15	60	Canada	None		
20298224	220V	1	NEMA 6-20	60	Canada	None		

PC150 Standard Series Crimper

The PC150 is a stationary crimper with more power to manufacture factory-quality hose assemblies quickly and easily. Its open design with removable pusher and "slide in" die configuration allows for good visibility and easy loading of dies and hose assemblies. Crimp diameter is set and controlled with an easy-to-read metric micrometer. Designed to handle higher volumes in a shop environment.

The PC150 standard package includes: Metric micrometer, electronic stop switch, adjustable retraction stop, removable pusher, standard compression ring, adjustable coupling stop, pneumatic start/stop pendant switch, spare of springs and screws, Continental digital caliper, and CRIMPX die lubricant grease can w/ brush.

PC150 Standard Features

IDEAL FOR THE WORKSHOP ENVIRONMENT

- 80 tons of crimping force
- Two piece "slide in" die design for easy installation
- Retraction stop and electronic stop switch combine to speed up repetitive crimps



PC150 Standard dies



Micrometer is fully adjustable for a precise crimp



Retraction Stop limits ram retraction for quick repetitive crimps



Open design allows the operator to accurately position the fitting prior to crimping



Coupling Stop makes repetitive crimps faster by not having to visually align the fitting before each crimp



Electronic Stop Switch shuts the pump off when the crimp cycle is complete



Easy calibration adjustment to increase or decrease the crimp diameter

PC150 Double Angle Series Crimper

CAPABILITY

- (¼" thru 2") B2 Fittings
- (1-½") SG Fittings

TECHNICAL DATA

- **CRIMPING FORCE** 80 Ton
- **WEIGHT** 305 lbs. (crimper only)
- **DIMENSIONS** 32" L x 17" W x 29" H
- **DIE SERIES** PC150 Double Angle
- **OIL CAPACITY** 1 gal.



SAP #	Voltage	Phase	Plug	Hertz	Country Approved	Dies Included	Die Sizes (MM)	Die Shelf Included
21095559	110V	1	NEMA 5-15	60	U.S.A	10	16, 19, 23, 27, 31, 34, 41, 50, 56 + (53DA)	✓
21095558	220V	1	NEMA 6-20	60	U.S.A	10	16, 19, 23, 27, 31, 34, 41, 50, 56 + (53DA)	✓
21095950	110V	1	NEMA 5-15	60	Canada	10	16, 19, 23, 27, 31, 34, 41, 50, 56 + (53DA)	✓
21095951	220V	1	NEMA 6-20	60	Canada	10	16, 19, 23, 27, 31, 34, 41, 50, 56 + (53DA)	✓

PC150 Double Angle Series Crimper

The PC150 is a stationary crimper with more power to manufacture factory-quality hose assemblies quickly and easily. Its open design with removable pusher and “two halves double angle” die configuration allows for good visibility and easy loading of dies and hose assemblies. Crimp diameter is set and controlled with an easy-to-read metric micrometer.

Designed to handle higher volumes in a shop environment.

The PC150 standard package includes: Metric micrometer, electronic stop switch, adjustable retraction stop, removable pusher, double angle top and base, adjustable coupling stop, pneumatic start/stop pendant switch, spare of springs and screws, Continental digital caliper, and CRIMPX die lubricant grease can w/ brush.

PC150 Double Angle Features

PC150 SPACER KIT

- Easy functions to enable you to quickly and accurately to change from PC150 dies to PC150 Double Angle dies
- PC150 Spacer Kit ideal for crimping extra long elbow fittings
- Adds exactly 1" between the pusher and DBL TOP Cone to allow extra fitting clearance



Micrometer is fully adjustable for a precise crimp



Retraction Stop limits ram retraction for quick repetitive crimps



Open design allows the operator to accurately position the fitting prior to crimping



Electronic Stop Switch shuts the pump off when the crimp cycle is complete



PC150 Double Angle dies



PC150 Spacer Kit ideal for crimping extra long elbow fittings



Easy calibration adjustment to increase or decrease the crimp diameter

PC150HD Series Crimper

CAPABILITY

- 1/4" through 2" ID, 2-braid hose and 1 1/4" 6-spiral hose with all coupling end styles and most bent tubes.

TECHNICAL DATA

- **CRIMPING FORCE** 240 Ton
- **WEIGHT** 400 lbs. (crimper only)
- **DIMENSIONS** 17-1/2" L x 25" W x 25" H
- **DIE SERIES** PC150H
- **OIL CAPACITY** 6 gal.



SAP #	Voltage	Phase	Plug	Hertz	Country Approved	Dies Included	Die Sizes (MM)	9 Station Die Rack Included
21053598	110V	1	NEMA 5-15	60	U.S.A	(12)	16, 19, 23, 27, 31, 34, 41, 45, 50, 53, 56, 69	✓
21053599	220V	1	NEMA 6-20	60	U.S.A	(12)	16, 19, 23, 27, 31, 34, 41, 45, 50, 53, 56, 69	✓

EQUIPMENT



Crimpers

PC150HD Series

PC150HD Series Crimper

The PC150HD crimper is a compact engineered design to handle higher volumes in a shop environment with the dial micrometer and 240 tons of crimping force providing the capability to crimp up to 2" industrial hose.

The PC150HD standard package includes: Dial micrometer, foot switch, 84mm quick change tool, 9 station die rack, manual back stop, protective master die foam pads, spare of die studs and quick change tool pins, Continental digital caliper, and mini grease gun w/ CRIMPX die lubricant grease tube.

PC150HD Features

PC150HD COMPACT ENGINEERED DESIGN

- Easy operating control system
- Visible oil level through the sight glass and two oil drains ports
- Compact design to fit in the workshop
- Perfect for workshops and on-site services



Dial Micrometer is fully adjustable, provides speed, precision and repeatability



Easy operating control system using Open/Close green push button or the foot switch



Manual back stop speeds multiple crimps of the same hose and fitting



Easy grease maintenance through the 8 lubrication fittings



Quick change tool makes die changes a quick and simple process



The Foot Switch permits dies to be "jogged" into position and keeps both hands free

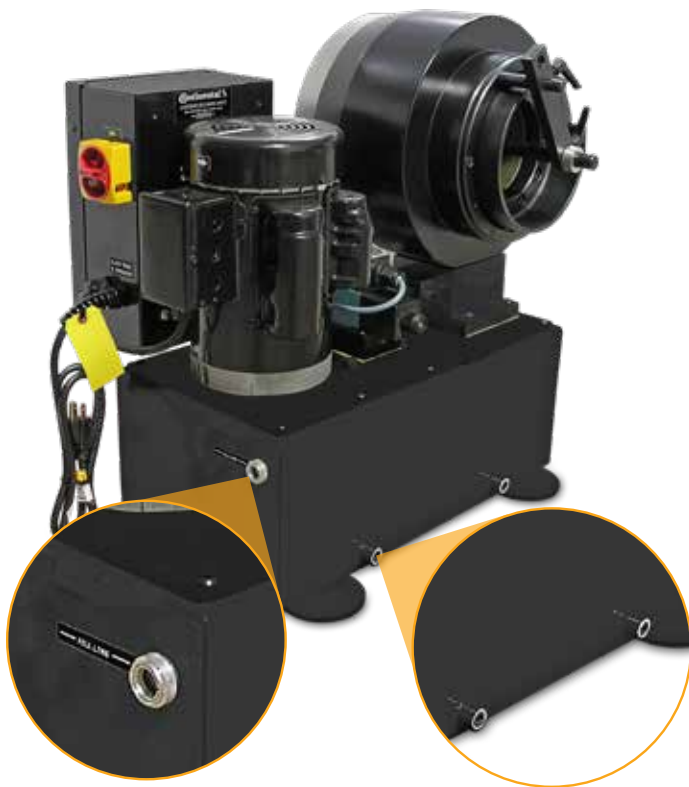

PC200M Series Crimper

CAPABILITY

- 1/4" through 2" ID, 2-braid hose and 2" 6-spiral hose with all coupling end styles and most bent tubes.

TECHNICAL DATA

- **CRIMPING FORCE** 340 Ton
- **WEIGHT** 635 lbs. (crimper only)
- **DIMENSIONS** 20" L x 29" W x 32" H
- **HYDRAULIC DIE SERIES** PC200
- **ADAPTER DIE SERIES** 130MM to 99MM
- **OIL CAPACITY** 8 gal.



SAP #	Voltage	Phase	Plug	Hertz	Country Approved	Dies Included	Die Sizes (MM)	PC200-Rack Included
20442513	230V	1	NEMA L6-30P	60	U.S.A	(14)	16, 19, 23, 27, 31, 34, 41, 45, 50, 53, 59, 62, 74, 78	✓
21095952	230V	3	NEMA L15-20P	60	U.S.A	(14)	16, 19, 23, 27, 31, 34, 41, 45, 50, 53, 59, 62, 74, 78	✓
21095953	440 - 480V	3	NEMA L1620P	60	U.S.A	(14)	16, 19, 23, 27, 31, 34, 41, 45, 50, 53, 59, 62, 74, 78	✓
21007698	24VDC	1	Jumper Cables	N/A	Any	(14)	16, 19, 23, 27, 31, 34, 41, 45, 50, 53, 59, 62, 74, 78	✓

EQUIPMENT



Crimpers

PC200M Series

PC200M Series Crimper

The PC200M crimper is a compact engineered design to handle higher volumes in a shop environment with the dial micrometer and 340 tons of crimping force providing the capability to crimp up to 3" industrial hose.

The PC200M standard package includes: Dial micrometer, foot switch, 99mm QCT, PC200-Rack, manual back stop, protective master die foam pads, (1) adapter die set, adapter die removal tool, spare of die studs and QCT pins, Continental digital caliper, and mini grease gun w/ CRIMPX die lubricant grease tube.

PC200M Features

PC200-RACK

- The PC200M crimper comes with a (5) die storage pockets panel installed
- The PC200M crimper can be mounted on the PC200-Rack
- The PC200-Rack is a machine stand with (16) PC200 die storage pockets to keep frequently used die sets readily available



Dial Micrometer is fully adjustable, provides speed, precision and repeatability



Quick change tool makes die changes a quick and simple process



Manual back stop speeds multiple crimps of the same hose and fitting



Easy grease maintenance through the 8 lubrication fittings



5 die storage pockets panel installed to keep frequently used die sets readily available



The Foot Switch permits dies to be "jogged" into position and keeps both hands free

UNWRAP YOUR NEW CONTINENTAL SHOP IN A BOX





GENERATE MORE REVENUE WITH CONTINENTAL'S SHOP IN A BOX.

Now you can create a hydraulic and industrial hose crimp shop right inside your current location with Continental's Shop In A Box. This turnkey setup contains a crimper and all the accessories you need to produce premium Continental assemblies. With five available options to meet your needs, this new assembly solution is ready to perform.

Your SIAB Includes:

- Crimper
- CrimpIQ™ Tablet
- Hose Saw
- Hose Reel Rack
- Die Shelf
- Insertion Block Assembly
- Continental Calipers
- 4 Drawer Cabinet with Small and Large Bins
- Hose Helper
- 10' Continental Air Hose with Nozzle
- 6' Continental Sign
- 6' LED Light Kit
- Attached Tape Measure
- 5' 110V Power Strip
- Tooling Mat
- Work Table with Adjustable Feet

PC125-RCD Shop in a Box

CAPABILITY

- The HS-150 is designed to cut 1- and 2-braid hydraulic hose up to 1 1/2" ID and up to 1 1/4" 4-spiral hose.
- The PC125-RCD is designed to crimp (-20) B2 Fittings and (-16) SG Fittings



SAP #	HS-150 Voltage	Phase	Plug	Hertz	Country Approved	Hose Helper Included	Serrated Blade, Hose Bending Pins & 1-1/4" Vacuum Adapter Included	24" Hose Reel Rack Included
21091383	110V	1	NEMA 5-15	60	U.S.A	✓	✓	✓
	PC125-RCD Voltage	Phase	Plug	Hertz	Country Approved	Dies Included	Die Sizes (MM)	
	110V	1	NEMA 5-15	60	U.S.A	(8)	16, 19, 23, 27, 31, 34, 43, 50	

EQUIPMENT



PC125-RCD

Shop in a Box

PC125-RCD Shop in a Box

Now you can create a hydraulic hose crimp shop right inside your current location with PC125-RCD Shop in a Box. This turnkey setup is a new assembly solution containing a hose saw, crimper and all the accessories you need to produce premium Continental assemblies.

Full Turnkey Solution

PC125-RCD SHOP IN A BOX FEATURES

- Everything you need right inside your current location
- To produce premium Continental hydraulic hose assemblies

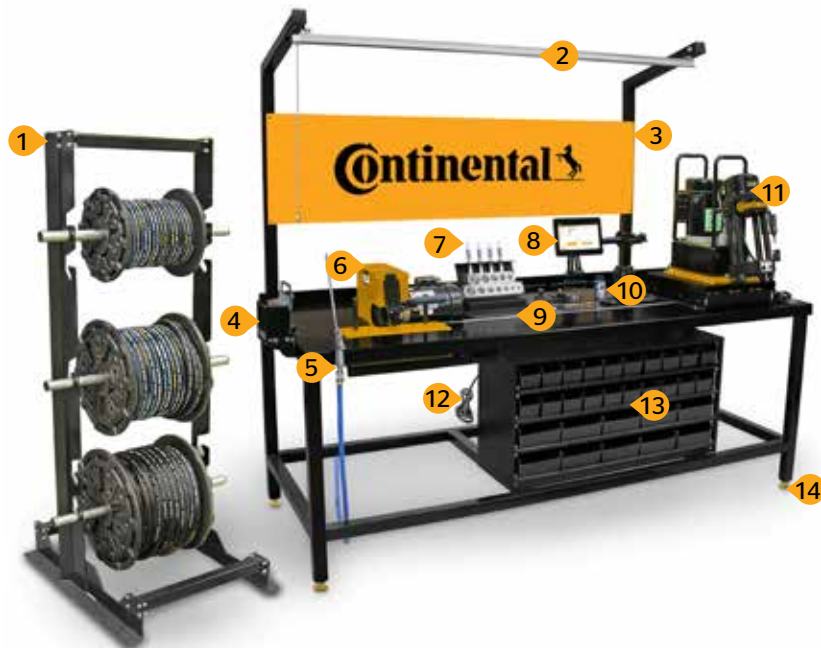

PC125-RCD Shop in a Box standard package includes	
(#1) 24" Hose Reel Rack (Hose spools not included)	(#8) CrimpIQ™ Tablet and Mounting Arm
(#2) 6' LED Light Kit	(#9) Tape Measure
(#3) 6' Continental Sign	(#10) PC125-RCD Tooling Box, and Tooling Mat
(#4) Hose Helper	(#11) PC125-RCD Crimper (Dies, Drawer, and Tooling Box)
(#5) 10' Continental Air Hose with Nozzle	(#12) 5' 110V Power Strip
(#6) HS-150 Hose Saw (Handle, Vacuum Port, and Alignment Pins)	(#13) 4 Drawer Cabinet with Small and Large Bin
(#7) Insertion Block Assembly (B2 and SG blocks, (5) Paint Markers)	(#14) Adjustable Feet

PC125-RCD
Shop in a box

EQUIPMENT
Continental

PC150-2 Shop in a Box

CAPABILITY

- The HS-501 is designed to cut 1- and 2-braid hydraulic hose up to 2" ID and up to 2" 4- or 6-spiral hose.
- The PC150-2 is designed to crimp (1-½") B2 Fittings and (1-¼") SG Fittings.



SAP #	HS-501 Voltage	Phase	Plug	Hertz	Country Approved	Hose Helper Included	Serrated Blade, Hose Bending Pins & 1-1/4" Vacuum Adapter Included	36" Hose Reel Rack Included
21091384	230V	1	NEMA L6-30P	60	U.S.A	✓	✓	✓
	PC150-2 Voltage	Phase	Plug	Hertz	Country Approved	Dies Included	Die Sizes (MM)	
	220V	1	NEMA 6-20	60	U.S.A	(9)	16, 19, 23, 27, 31, 34, 41, 50, 56	

EQUIPMENT



PC150-2

Shop in a Box

PC150-2 Shop in a Box

Now you can create a hydraulic hose crimp shop right inside your current location with PC150-2 Shop in a Box. This turnkey setup is a new assembly solution containing a hose saw, crimper and all the accessories you need to produce premium Continental assemblies.

Full Turnkey Solution

PC150-2 SHOP IN A BOX FEATURES

- Everything you need right inside your current location
- To produce premium Continental hydraulic hose assemblies

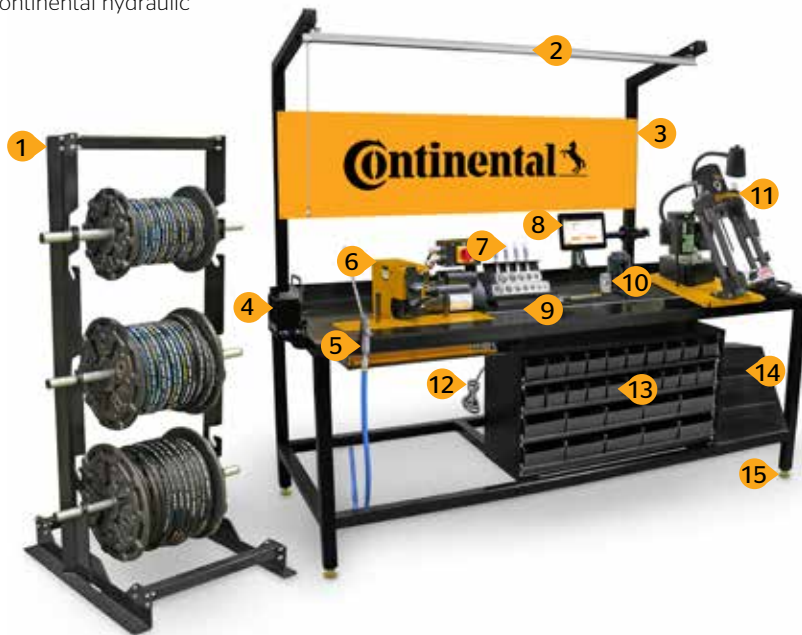

PC150-2 Shop in a Box standard package includes	
(#1) 36" Hose Reel Rack (Hose spools not included)	(#9) Tape Measure
(#2) 6' LED Light Kit	(#10) PC150-2 Tooling Box, and Tooling Mat
(#3) 6' Continental Sign	(#11) PC150-2 Crimper (Dies, Shelf and Tooling Box)
(#4) Hose Helper	(#12) 5' 110V Power Strip
(#5) 10' Continental Air Hose with Nozzle	(#13) 4 Drawer Cabinet with Small and Large Bin
(#6) HS-501 Hose Saw (Handle, Vacuum Port, and Alignment Pins)	(#14) Die Shelf
(#7) Insertion Block Assembly (B2 and SG blocks, (5) Paint Markers)	(#15) Adjustable Feet
(#8) CrimpIQ™ Tablet and Mounting Arm	

PC150-2
Shop in a box

PC150HD Shop in a Box

CAPABILITY

- The HS-501 is designed to cut 1- and 2-braid hydraulic hose up to 2" ID and up to 2" 4- or 6-spiral hose.
- PC150HD is designed to crimp 1/4" through 2" ID, 2-braid hose and 1 1/4" 6-spiral hose with all coupling end styles and most bent tubes.



SAP #	HS-501 Voltage	Phase	Plug	Hertz	Country Approved	Hose Helper Included	Serrated Blade, Hose Bending Pins & 1-1/4" Vacuum Adapter Included	36" Hose Reel Rack Included
21100773	230V	1	NEMA L6-30P	60	U.S.A	✓	✓	✓
	PC150HD Voltage	Phase	Plug	Hertz	Country Approved	Dies Included	Die Sizes (MM)	
	220V	1	NEMA 6-20	60	U.S.A	(12)	16, 19, 23, 27, 31, 34, 41, 45, 50, 53, 56, 69	

EQUIPMENT



PC150HD

Shop in a Box

PC150HD Shop in a Box

Now you can create a hydraulic hose crimp shop right inside your current location with PC150HD Shop in a Box. This turnkey setup is a new assembly solution containing a hose saw, crimper and all the accessories you need to produce premium Continental assemblies.

Full Turnkey Solution

PC150HD SHOP IN A BOX FEATURES

- Everything you need right inside your current location
- To produce premium Continental hydraulic hose assemblies

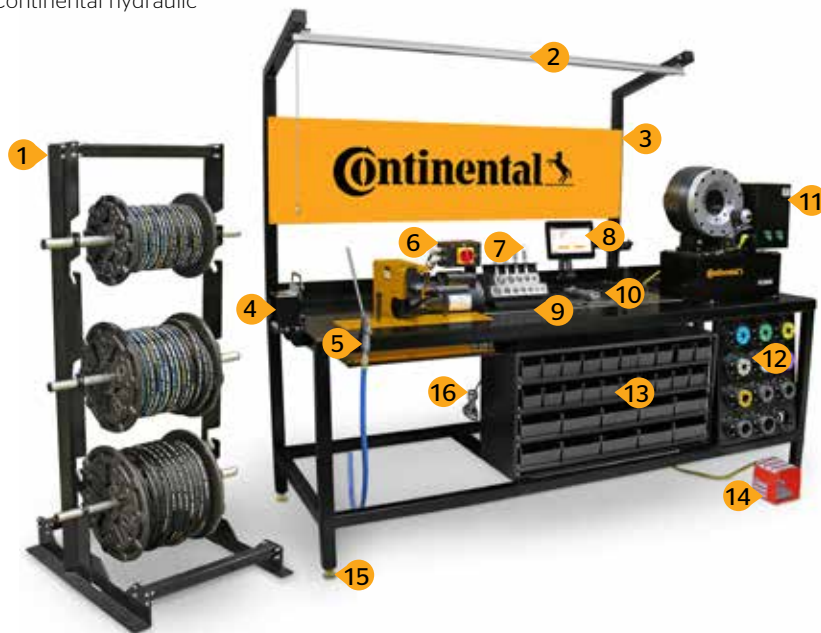

PC150HD Shop in a Box standard package includes	
(#1) 36" Hose Reel Rack (Hose spools not included)	(#9) Tape Measure
(#2) 6' LED Light Kit	(#10) PC150HD Tooling Box, and Tooling Mat
(#3) 6' Continental Sign	(#11) PC150HD Crimper (Dies, Rack, and Tooling Box)
(#4) Hose Helper	(#12) Die Rack
(#5) 10' Continental Air Hose with Nozzle	(#13) 4 Drawer Cabinet with Small and Large Bin
(#6) HS-501 Hose Saw (Handle, Vacuum Port, and Alignment Pins)	(#14) Foot Pedal
(#7) Insertion Block Assembly (B2 and SG blocks, (5) Paint Markers)	(#15) Adjustable Feet
(#8) CrimpIQ™ Tablet and Mounting Arm	(#16) 5' 110V Power Strip

PC150HD
Shop in a box

EQUIPMENT
Continental

PC200i Shop in a Box

CAPABILITY

- The HS-501 is designed to cut 1- and 2-braid hydraulic hose up to 2" ID and up to 2" 4- or 6-spiral hose.
- PC200i is designed to crimp 1/4" through 2" ID, 2-braid hose and 2" 6 spiral hose with all coupling end styles and most bent tubes.



SAP #	Voltage	Phase	Plug	Hertz	Country Approved	Dies Included	Die Sizes (MM)	36" Hose Reel Rack Included
21100775	230V	1	NEMA L6-30P	60	U.S.A	(14)	16, 19, 23, 27, 31, 34, 41, 45, 50, 53, 59, 62, 74, 78	✓
21100777	230V	3	NEMA L15-20P	60	U.S.A	(14)	16, 19, 23, 27, 31, 34, 41, 45, 50, 53, 59, 62, 74, 78	✓
21100518	440 - 480V	3	NEMA L1620P	60	U.S.A	(14)	16, 19, 23, 27, 31, 34, 41, 45, 50, 53, 59, 62, 74, 78	✓

*Please contact customer service for the hose saw voltage availability.

PC200i Shop in a Box

Now you can create a hydraulic hose crimp shop right inside your current location with PC200i Shop in a Box. This turnkey setup is a new assembly solution containing a hose saw, crimper and all the accessories you need to produce premium Continental assemblies.

Full Turnkey Solution

PC200i SHOP IN A BOX FEATURES

- Everything you need right inside your current location
- To produce premium Continental hydraulic hose assemblies



PC200i Shop in a Box standard package includes	
(#1) 36" Hose Reel Rack (Hose spools not included)	(#9) Tape Measure
(#2) 6' LED Light Kit	(#10) PC200i Tooling Box, and Tooling Mat
(#3) 6' Continental Sign	(#11) PC200i Crimper (Dies, PC200 Rack, and Tooling Box)
(#4) Hose Helper	(#12) PC200-Rack
(#5) 10' Continental Air Hose with Nozzle	(#13) 4 Drawer Cabinet with Small and Large Bin
(#6) HS-501 Hose Saw (Handle, Vacuum Port, and Alignment Pins)	(#14) Foot Pedal
(#7) Insertion Block Assembly (B2 and SG blocks, (5) Paint Markers)	(#15) Adjustable Feet
(#8) CrimpIQ™ Tablet and Mounting Arm	(#16) 5' 110V Power Strip

PC200i
Shop in a box

EQUIPMENT
Continental

The future of crimping at your fingertips

Continental introduces the new CrimpIQ™ controller – the next generation of hose crimpers.



tips.

ation, intelligent, cloud-based controller for hydraulic and industrial

PC200i Series with CrimpIQ™ Controller

CAPABILITY

- 1/4" through 2" ID, 2-braid hose and 2" 6 spiral hose with all coupling end styles and most bent tubes.

TECHNICAL DATA

- **CRIMPING FORCE** 340 Ton
- **WEIGHT** 635 lbs. (crimper only)
- **DIMENSIONS** 20" L x 29" W x 32" H
- **HYDRAULIC DIE SERIES** PC200
- **ADAPTER DIE SERIES** 130MM to 99MM
- **OIL CAPACITY** 8 gal.



SAP #	Voltage	Phase	Plug	Hertz	Country Approved	Dies Included	Die Sizes (MM)	PC200-Rack Included
21006081	230V	1	NEMA L6-30P	60	U.S.A	(14)	16, 19, 23, 27, 31, 34, 41, 45, 50, 53, 59, 62, 74, 78	✓
21006080	230V	3	NEMA L15-20P	60	U.S.A	(14)	16, 19, 23, 27, 31, 34, 41, 45, 50, 53, 59, 62, 74, 78	✓
21006011	440 - 480V	3	NEMA L1620P	60	U.S.A	(14)	16, 19, 23, 27, 31, 34, 41, 45, 50, 53, 59, 62, 74, 78	✓
21006082	230V	1	NEMA L6-30P	60	Canada	(14)	16, 19, 23, 27, 31, 34, 41, 45, 50, 53, 59, 62, 74, 78	✓
21006083	230V	3	NEMA L1530-P	60	Canada	(14)	16, 19, 23, 27, 31, 34, 41, 45, 50, 53, 59, 62, 74, 78	✓
21006013	575V	3	Not Supplied	60	Canada	(14)	16, 19, 23, 27, 31, 34, 41, 45, 50, 53, 59, 62, 74, 78	✓
21006005	230V	1	NEMA L6-30P	60	U.S.A	None		✓
21006000	230V	3	NEMA L15-20P	60	U.S.A	None		✓

EQUIPMENT



Crimpers

PC200i Series with CrimpIQ™ Controller

PC200i Series with CrimpIQ™ Controller

The PC200i is a high-volume, high-capacity stationary crimper featuring the Continental CrimpIQ™ Controller powered by Continental Fluid Solutions technology. This technology provides direct access to all crimping specifications and information. It supports a user-friendly interface to guide new and advanced users through the crimping process quickly and easily. Crimp settings, dwell time, pre-start positions and auto/manual operations are all easily set with electronic controls.

The PC200i standard package includes: 10-inch color capacitive touch screen, foot switch, 99mm QCT, manual back stop, PC200-Rack, protective master die foam pads, (1) adapter die set, adapter die removal tool, spare die studs and QCT pins, Continental bluetooth digital caliper, and mini grease gun w/ CRIMPX die lubricant grease tube.

PC200i Features

PC200-RACK

- The PC200i crimper can be mounted on the PC200-Rack
- The PC200-Rack is a machine stand with (16) PC200 die storage pockets to keep frequently used die sets readily available



Continental CrimpIQ™ controller, the future of crimping at your fingertips



10-inch color capacitive touch screen and user friendly navigation



Intuitive screens lead the operator through the setup and crimping process



CrimpIQ™ controller supports bluetooth calipers to input crimp diameter measurements



Easy grease maintenance through the 8 lubrication fittings



Quick change tool makes die changes a quick and simple process

PC440i Series with CrimplQ™ Controller

CAPABILITY

- 1/4" through 2" ID, 2-braid hose, 2" 6-spiral hose and 4" industrial hose with all coupling end styles including most bent tubes.
- 1/2" through 4" ID industrial hose.

TECHNICAL DATA

- **CRIMPING FORCE** 265 Ton
- **WEIGHT** 1,840 lbs. (crimper only)
- **DIMENSIONS** 46-1/2" L x 52" W x 67" H
- **HYDRAULIC DIE SERIES** PC200
- **ADAPTER DIE SERIES** 160MM to 99MM
- **INDUSTRIAL DIE SERIES** 160S
- **OIL CAPACITY** 8 gal.



SAP #	Voltage	Phase	Plug	Hertz	Country Approved	Dies Included	Die Sizes (MM)	Die Shelf Included
21006084	230V	1	NEMA L6-30P	60	U.S.A	(14)	16, 19, 23, 27, 31, 34, 41, 45, 50, 53, 59, 62, 74, 78	✓
21006085	230V	3	NEMA L15-20P	60	U.S.A	(14)	16, 19, 23, 27, 31, 34, 41, 45, 50, 53, 59, 62, 74, 78	✓
21095954	480V	3	NEMA L1620P	60	U.S.A	(14)	16, 19, 23, 27, 31, 34, 41, 45, 50, 53, 59, 62, 74, 78	✓
21006007	230V	1	NEMA L6-30P	60	U.S.A	None		✓
21006002	230V	3	NEMA L15-20P	60	U.S.A	None		✓

EQUIPMENT



Crimpers

PC440i Series with CrimplQ™ Controller

PC440i Series with CrimpIQ™ Controller

The PC440i features the Continental CrimpIQ™ Controller powered by Continental Fluid Solutions technology, providing direct access to all crimping specifications and information. It supports a user-friendly interface to guide new and advanced users through the crimping process quickly and easily. The PC440i can track number of crimps and automatically pause for a quality-check at preset intervals. Its pressure transducer monitors crimping “effort” eliminating trial-and-error crimping. The PC440i standard package includes: 10-inch color capacitive touch screen, adjustable mirror, foot switch, 99mm QCT, manual back stop, (1) adapter die set, adapter die removal T-handle hex, spare die studs and QCT pins, Continental bluetooth digital caliper, and mini grease gun w/ CRIMPX die lubricant grease tube.

PC440i Features

BUILT-IN DIE STORAGE

- The PC440i crimper comes with (12) PC200 die storage pockets to keep frequently used die sets readily available

MANUAL BACK STOP

- The manual back stop speeds multiple crimps of the same hose and fitting

GREASE MAINTENANCE

- The lubrications fittings on the crimper makes grease maintenance easier to keep the crimper lubricated for a good performance



Continental CrimpIQ™ controller, the future of crimping at your fingertips



10-inch color capacitive touch screen and user friendly navigation



Intuitive screens lead the operator through the setup and crimping process



CrimpIQ™ controller supports blue-tooth calipers to input crimp diameter measurements



Quick change tool makes die changes a quick and simple process



Fixed 6 o'clock die position allows the operator to place the fitting on bottom die and crimp

PC600i Series with CrimpIQ™ Controller

CAPABILITY

- 1/4" through 2 1/2" ID, 2-braid and 6-spiral hydraulic hose.
- 3/16" through 6" ID industrial hose.

TECHNICAL DATA

- **CRIMPING FORCE** 350 Ton
- **WEIGHT** 4,000 lbs. (crimper only)
- **DIMENSIONS** 49" L x 54" W x 69" H
- **HYDRAULIC DIE SERIES** PC200
- **ADAPTER DIE SERIES** 160MM to 99MM
- **INDUSTRIAL DIE SERIES** 160 OB
- **OIL CAPACITY** 24 gal.



SAP #	Voltage	Phase	Plug	Hertz	Country Approved	Dies Included	Die Sizes (MM)	Die Shelf Included
21006089	230V	1	NEMA L6-30P	60	U.S.A	(22)	16, 19, 23, 27, 31, 34, 41, 45, 50, 53, 59, 62, 74, 78, 84, 92, 100, 108, 116, 126, 166, 178	✓
21006088	230V	3	NEMA L15-20P	60	U.S.A	(22)	16, 19, 23, 27, 31, 34, 41, 45, 50, 53, 59, 62, 74, 78, 84, 92, 100, 108, 116, 126, 166, 178	✓
21006090	440 - 480V	3	NEMA L1620P	60	U.S.A	(22)	16, 19, 23, 27, 31, 34, 41, 45, 50, 53, 59, 62, 74, 78, 84, 92, 100, 108, 116, 126, 166, 178	✓
21006087	230V	1	NEMA L6-30P	60	U.S.A	(14)	16, 19, 23, 27, 31, 34, 41, 45, 50, 53, 59, 62, 74, 78	✓
21006086	230V	3	NEMA L15-20P	60	U.S.A	(14)	16, 19, 23, 27, 31, 34, 41, 45, 50, 53, 59, 62, 74, 78	✓
21006021	440 - 480V	3	NEMA L1620P	60	U.S.A	(14)	16, 19, 23, 27, 31, 34, 41, 45, 50, 53, 59, 62, 74, 78	✓
21006008	230V	1	NEMA L6-30P	60	U.S.A	None		✓
21006003	230V	3	NEMA L15-20P	60	U.S.A	None		✓

EQUIPMENT



Crimpers

PC600i Series with CrimpIQ™ Controller

PC600i Series with CrimpIQ™ Controller

The PC600i is a high-volume, high-capacity stationary crimper featuring the Continental CrimpIQ™ Controller powered by Continental Fluid Solutions technology. This technology provides direct access to all crimping specifications and information. It supports a user-friendly interface to guide new and advanced users through the crimping process quickly and easily. The PC600i can produce 2,200 crimps per hour with 350 tons of crimping force to allow for both hydraulic and industrial hose assemblies.

The PC600i standard package includes: 10-inch color capacitive touch screen, adjustable mirror, foot switch, 99mm QCT, manual back stop, (1) adapter die set, adapter die removal T-handle hex, spare die studs and QCT pins, Continental bluetooth digital caliper, and mini grease gun w/ CRIMPX die lubricant grease tube.

PC600i Features

BUILT-IN DIE STORAGE

- The PC600i crimper comes with (16) PC200 die storage pockets and (6) industrial die storage shelves to keep frequently used die sets readily available

MANUAL BACK STOP

- The manual back stop speeds multiple crimps of the same hose and fitting

GREASE MAINTENANCE

- The lubrications fittings on the crimper makes grease maintenance easier to keep the crimper lubricated for a good performance



Continental CrimpIQ™ controller, the future of crimping at your fingertips



10-inch color capacitive touch screen and user friendly navigation



Intuitive screens lead the operator through the setup and crimping process



CrimpIQ™ controller supports bluetooth calipers to input crimp diameter measurements



Quick change tool makes die changes a quick and simple process



Use the foot pedal to close the crimper head when crimping in semi and full automatic mode

Crimpers

PC600i Series with CrimpIQ™ Controller

EQUIPMENT



PC1000i Series with CrimplQ™ Controller

CAPABILITY

- Up through 2 ½" ID, 2-braid, 4-spiral and 6-spiral hydraulic hose.
- 3/16" through 10" ID industrial hose.

TECHNICAL DATA

- **CRIMPING FORCE** 485 Ton
- **WEIGHT** 6,185 lbs. (crimper only)
- **CRIMPER DIMENSIONS** 54" L x 62" W x 86" H
- **POWER UNIT DIMENSIONS** 28" L x 33-½" W x 45" H
- **HYDRAULIC DIE SERIES** PC200
- **ADAPTER DIE SERIES** 230MM to 145MM
145MM TO 99MM
- **INDUSTRIAL DIE SERIES** 230 OB
- **OIL CAPACITY** 45 gal.



SAP #	Voltage	Phase	Plug	Hertz	Country Approved	Dies Included	Die Sizes (MM)	Die Shelf Included
21071067	230V	1	NEMA L6-30P	60	U.S.A	(24)	16, 19, 23, 27, 31, 34, 41, 45, 50, 53, 59, 62, 74, 78, 84, 92, 100, 108, 116, 126, 166, 178, 215, 245	✓
21006091	230V	3	NEMA L15-20P	60	U.S.A	(24)	16, 19, 23, 27, 31, 34, 41, 45, 50, 53, 59, 62, 74, 78, 84, 92, 100, 108, 116, 126, 166, 178, 215, 245	✓
21006009	230V	1	NEMA L6-30P	60	U.S.A	None		✓
21006004	230V	3	NEMA L15-20P	60	U.S.A	None		✓

EQUIPMENT



Crimpers

PC1000i Series with CrimplQ™ Controller

PC1000i Series with CrimplQ™ Controller

The PC1000i is a high-volume, high-capacity stationary crimper featuring the Continental CrimplQ™ Controller powered by Continental Fluid Solutions technology. This technology provides direct access to all crimping specifications and information. It supports a user-friendly interface to guide new and advanced users through the crimping process quickly and easily. The PC1000i can produce 1,415 crimps per hour with 485 tons of crimping force to allow for both hydraulic and industrial hose assemblies and is ideal for production assembly applications.

The PC1000i standard package includes: 10-inch color capacitive touch screen, adjustable mirror, foot switch, 99mm QCT, manual back stop, (2) adapter die sets, adapter die removal T-handle hex, spare die studs and QCT pins, Continental bluetooth digital caliper, and mini grease gun w/ CRIMPX die lubricant grease tube.

PC1000i Features

BUILT-IN DIE STORAGE

- The PC1000i crimper comes with (15) PC200 die storage pockets and (10) industrial die storage shelves to keep frequently used die sets readily available

MANUAL BACK STOP

- The manual back stop speeds multiple crimps of the same hose and fitting

GREASE MAINTENANCE

- The lubrication fittings on the crimper makes grease maintenance easier to keep the crimper lubricated for a good performance



Continental CrimplQ™ controller, the future of crimping at your fingertips



10-inch color capacitive touch screen and user friendly navigation



Intuitive screens lead the operator through the setup and crimping process



CrimplQ™ controller supports bluetooth calipers to input crimp diameter measurements



Quick change tool makes die changes a quick and simple process



Use the foot pedal to close the crimper head when crimping in semi and full automatic mode

PC1200i Series with CrimpIQ™ Controller

CAPABILITY

- Up through 2 1/2" ID, 2-braid, 4-spiral and 6-spiral hydraulic hose.
- 3/16" through 12" ID industrial hose.

TECHNICAL DATA

- **CRIMPING FORCE** 830 Ton
- **WEIGHT** 10,000 lbs. (crimper only)
- **CRIMPER DIMENSIONS** 60" L x 56" W x 78" H
- **POWER UNIT DIMENSIONS** 36" L x 48" W x 60" H
- **HYDRAULIC DIE SERIES** PC200
- **ADAPTER DIE SERIES** 330MM to 230MM
230MM TO 160MM
160MM TO 99MM
- **INDUSTRIAL DIE SERIES** 160S/230XL/330S/330OB
- **OIL CAPACITY** 80 gal.



SAP #	Voltage	Phase	Plug	Hertz	Country Approved	Dies Included	Die Sizes (MM)	Die Shelf Included
21023980	440 - 480V	3	NEMA L1620P	60	U.S.A	(25)	41, 45, 50, 53, 56, 62, 69, 75, 74, 78, 84, 92, 100, 108, 116, 126, 166, 178, 190, 215, 245, 281, 311, 333, 349	✓

EQUIPMENT



Crimpers

PC1200i Series with CrimpIQ™ Controller

PC1200i Series with CrimplQ™ Controller

The PC1200i is a high-volume, high-capacity stationary crimper featuring the Continental CrimplQ™ Controller powered by Continental Fluid Solutions technology. This technology provides direct access to all crimping specifications and information. It supports a user-friendly interface to guide new and advanced users through the crimping process quickly and easily. The PC1200i can produce 830 tons of crimping force to allow for both hydraulic and industrial hose assemblies and is ideal for production assembly applications.

The PC1200i standard package includes: 10-inch color capacitive touch screen, foot switch, 99mm QCT, (3) adapter die sets, adapter die removal T-handle hex, spare die studs and QCT pins, Continental bluetooth digital caliper, and large grease gun w/ CRIMPX die lubricant grease tube.

PC1200i Features

BUILT-IN DIE STORAGE CABINETS

- The PC1200i crimper comes with front and back die storage cabinets
- (15) PC200 die storage pockets and (16) industrial die storage shelves to keep frequently used die sets readily available or any crimping accessories

GREASE MAINTENANCE

- The lubrications fittings on the crimper makes grease maintenance easier to keep the crimper lubricated for a good performance



Continental CrimplQ™ controller, the future of crimping at your fingertips



10-inch color capacitive touch screen and user friendly navigation



Intuitive screens lead the operator through the setup and crimping process



CrimplQ™ controller supports bluetooth calipers to input crimp diameter measurements



Quick change tool makes die changes a quick and simple process



Use the foot pedal to close the crimper head when crimping in semi and full automatic mode

HS-150 Series Hose Saw

CAPABILITY

- The HS-150 is designed to cut 1- and 2-braid hydraulic hose up to 1 1/2" ID and up to 1 1/4" 4-spiral hose.

TECHNICAL DATA

- **WEIGHT** 70 lbs. (hose saw only)
- **DIMENSIONS** 28-3/4" L x 21" W x 12-1/4" H



SAP #	Voltage	Phase	Plug	Hertz	Country Approved	Serrated Blade Included	Hose Bending Pins Included	1-1/4" Vacuum Adapter Included
20614553	110V	1	NEMA 5-15	60	U.S.A	✓	✓	✓
20829262	12VDC	1	Jumper Cables	N/A	Any	✓	✓	✓

EQUIPMENT



Hose Saws

HS-150 Series

HS-150 Series Hose Saw

The HS-150 hose saw is a rugged, compact, and lightweight engineered design ideal for small workshops with a low maintenance cost.

The HS-150 standard package includes: Serrated blade, hose bending pins, and 1-1/4" vacuum adapter.

HS-150 Features

AVAILABLE HS-150 MOBILE HOSE SAW

- Ideal for on-site service where electricity is not available
- 3 types of blades are available for HS-150 and HS-500 series: Serrated blade, Scalloped blade and Double Bevel w/SS Slots blade



Vacuum port allows attachment of vacuum system to keep saw and work space clean



Hose Bending Pins prevent the blade from binding during a cut

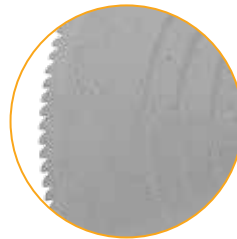

Serrated Blade is for general purpose and is recommended to cut multi-spiral hose



Scalloped Blade is for general purpose and is recommended to cut multi-spiral hose

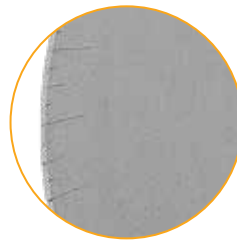

Double Bevel w/SS Slots Blade is recommended for braided hose with minimum debris during the cut

HS-500 Series Hose Saw

CAPABILITY

- The HS-500 is designed to cut 1- and 2-braid hydraulic hose up to 2" ID and up to 2" 4- or 6-spiral hose.

TECHNICAL DATA

- WEIGHT** 120 lbs. (hose saw only)
- DIMENSIONS** 29- $\frac{3}{4}$ " L x 26- $\frac{3}{4}$ " W x 16" H



SAP #	Voltage	Phase	Plug	Hertz	Country Approved	Serrated Blade Included	Hose Helper Included	Hose Bending Pins Included	1-1/4" Vacuum Adapter Included
20614557	230V	1	NEMA L6-30	60	U.S.A	✓	✓	✓	✓
20614556	230V	3	NEMA L15-20P	60	U.S.A	✓	✓	✓	✓
21095955	480V	3	NEMA L1620P	60	U.S.A	✓	✓	✓	✓

EQUIPMENT



Hose Saws

HS-500 Series

HS-500 Series Hose Saw

The HS-500 hose saw is a rugged engineered design, and the accessories included make it the best value of any hose saw in its class with a low maintenance cost.

The HS-500 standard package includes: Serrade blade, hose helper, hose bending pins, and 1-1/4" vacuum adapter.

HS-500 Features

HS-500 ACCESSORIES

- The HS-500 can be mounted on the HS-Mobile cart for easy moving around the shop
- The Hose Channel System both measures and supports the hoses up to 2 inch diameter as they are being cut
- 3 types of blades are available for HS150 and HS-500 series: Serrated blade, Scalloped blade and Double Bevel w/SS Slots blade



The mister sprays a fine mist of air tool oil on the saw blade for longer blade life and cleaner cuts



Hose Bending Pins prevent the blade from binding during a cut



Hose Helper attachment prevents the hose from being drawn back during a cut

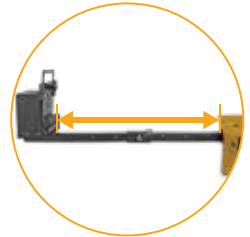

With the hose helper extension attached, can be adjusted up to 22" away from the hose saw base



A resettable counter makes it easy to keep track of the number of cuts made



Vacuum port allows attachment of vacuum system to keep saw and work space clean

SM300 Electric Hose Skiver Unit

CAPABILITY

- Capable of skiving up to 3 inches either internally or externally

TECHNICAL DATA

- **WEIGHT** 150 lbs. (hose skiver only)
175 lbs. (with optional mobile cart)
- **DIMENSIONS** 29" L x 25" W x 21" H (hose skiver only)
30" L x 29" W x 49" H (with optional mobile cart)



SM300 Electric Hose Skiver Unit is shown with optional accessories

SAP #	Voltage	Phase	Plug	Hertz	Country Approved	PTO Coupling Included	Foot Pedal Included
20687006	110V	1	NEMA L5-15	60	U.S.A	✓	✓

*ID / OD skiving tooling all available à la carte.

SM300 Electric Hose Skiver Unit

The SM300 Electric Hose Skiver Unit has the capacity to skive hoses from 1/2" to 3" either internally or externally. The quick change tooling, carbide cutting inserts and dual arm external skiver make this product an outstanding value.

SM300 Features

ID / OD SKIVING TOOLS

- OD and ID skive depth adjustability is easy and accurate
- OD carbide skiving insert blade has 4 useable cutting surfaces, which can be rotated quickly
- All OD and ID skiving tools are compatible with 300M hand operated skiving tool

BENCH TOP HOSE SKIVER

- The electric hose skiver unit can be mounted on a work bench
- Tool holder can be mounted on a work bench to keep the ID and OD skiving tools organized and readily available

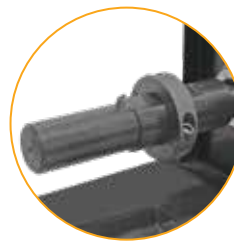

ID skiving tool with high speed steel cutting tool to provide clean ID skiving



OD skiving tool with long lasting carbide inserts have multiple cutting edges to eliminate sharpening



Laser etched scale is designed to help accurately calibrate the skive diameter



Change from OD to ID skiving tool in seconds with PTO coupling



Safety Switch activates and shuts the motor off when the safety shield is opened



Hose skiver unit and the tool holder can be mounted on the optional mobile cart

Electric Hose Skiver Unit
SM300 Series

EQUIPMENT
Continental

SM300M Hand Operated Hose Skiver Tool

CAPABILITY

- Capable of skiving up to 3 inches either internally or externally

TECHNICAL DATA

- **WEIGHT** 10 lbs.
- **DIMENSIONS** 14-3/8" L



SAP #	Hand Operated Hose Skiver Model	Country Approved	Powder Coat	PTO Coupling Included
21021146	SM300M	Any	Black	✓
*ID / OD skiving tooling all available á la carte.				

EQUIPMENT



Hand Operated Hose Skiver Tool

SM300M Series

SM300M Hand Operated Hose Skiver Tool

The SM300M hand operated hose skiver tool has the capacity to skive hoses from 1/2" to 3" either internally or externally. The quick change tooling, carbide cutting inserts and dual arm external skiver make this product an outstanding value.

SM300M Features

ID / OD SKIVING TOOLS

- OD and ID skive depth adjustability is easy and accurate
- OD carbide skiving insert blade has 4 useable cutting surfaces, which can be rotated quickly
- All OD and ID skiving tools are compatible with the electric hose skiver unit

HAND OPERATED HOSE SKIVER TOOL READY FOR USE

- The hand operated hose skiver tool is easily mounted in a vise and ready for use
- Tool holder can be mounted on a work bench to keep the ID and OD skiving tools organized and readily available



ID skiving tool with high speed steel cutting tool to provide clean ID skiving



OD skiving tool with long lasting carbide inserts have multiple cutting edges to eliminate sharpening

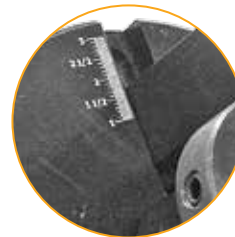

Laser etched scale is designed to help accurately calibrate the skive diameter



Change from OD to ID skiving tool in seconds with PTO coupling



Easily mounted in a vise and ready for use in the work shop



Tool holder is available separately to keep skiving tools organized and readily available

PCTB "PLC" Series Test Benches

CAPABILITY

Standard Test Benches

- PCTB-1500 – Test pressure range to 21,500 psi (1,500 bar)
- PCTB-2500 – Test pressure range to 37,500 psi (2,500 bar)

Industrial Test Benches

- PCTB-350 – Test pressure range to 5,000 psi (350 bar)
- PCTB-350/1500 – Test pressure range to 21,500 psi (1,500 bar)
- PCTB-350/2500 – Test pressure range to 40,000 psi (2,500 bar)

TECHNICAL DATA

- **WEIGHT** 955 lbs.
- **INSIDE CABINET DIMENSIONS** 67" L x 33" W x 17" H
- **OVERALL DIMENSIONS**
 - Standard Test Bench**
85" L x 39" W x 78" H
(closed 52" H)
 - Industrial Test Bench**
98" L x 50" W x 84" H
(closed 65" H)



SAP #	Voltage	Phase	Plug	Hertz	Standard PLC Bench	Industrial PLC Bench	Maximum Pressure	Low Pressure	Country Approved	Flowjet Booster Pump Included
20439764	110V	1	NEMA 5-15	50/60	✓		21,500PSI	5,000PSI	U.S.A.	
20554089	110V	1	NEMA 5-15	50/60	✓		37,500PSI	5,000PSI	U.S.A.	
20802395	110V	1	NEMA 5-15	50/60		✓	5,000PSI		U.S.A.	✓
20907994	110V	1	NEMA 5-15	50/60		✓	21,500PSI	5,000PSI	U.S.A.	✓
20783994	110V	1	NEMA 5-15	50/60		✓	40,000PSI	5,000PSI	U.S.A.	✓

PCTB "PLC" Series Test Benches

Whether you are producing a single assembly or a production run, Continental has the test equipment to give both you and your customer the assurance that the product has been assembled correctly. A programmable PLC Controller gives the operator the ability to pre-program and repeat a test sequence and print the results on the attached tape (optional save to USB).

CUSTOMIZED AND SPECIAL DESIGN BENCHES

In addition to the standard Electronic "PLC" series test benches, special purpose test benches can be designed by our engineering department, as well as an extension trough to meet specific requirements.

PCTB "PLC" Features

PCTB "PLC" SERIES

- 6-inch touch screen and user friendly navigation
- Full opening allows for hose assemblies to be loaded on a skid
- Built-in work light to facilitate monitoring the hose being tested
- Storage drawer to keep frequently used tools and your test bench accessories readily available



Intuitive screens lead the operator through the setup and test execution process



Multi-Port Manifold Outlet allows multiple hose assemblies to be tested at the same time



Safety Switch activates and drops pressure as soon as the lid is opened



Results of each test are recorded and can be printed on the included printer or saved via USB port



Removable side panel permits the testing of longer hose assemblies with the attachment of an optional trough



Available extension trough in 10 foot sections

PCTB "Manual" Series Test Benches

CAPABILITY

Standard Test Benches

- PCTB-1500 – Test pressure range to 21,500 psi (1500 bar)
- PCTB-2500 – Test pressure range to 37,500 psi (2500 bar)

TECHNICAL DATA

- **WEIGHT** 955 lbs.
- **INSIDE CABINET DIMENSIONS** 67" L x 33" W x 17" H
- **OVERALL DIMENSIONS** 85" L x 39" W x 78" H (closed 52" H)



SAP #	Voltage	Phase	Plug	Hertz	Standard Manual Bench	Maximum Pressure	Low Pressure	Country Approved
20439763	110V	1	NEMA 5-15	50/60	✓	21,500PSI	5,000PSI	U.S.A
20554088	110V	1	NEMA 5-15	50/60	✓	37,500PSI	5,000PSI	U.S.A

EQUIPMENT



PCTB "Manual" Test Benches

PCTB "Manual" Series

PCTB "Manual" Series Test Benches

The Continental PCTB "Manual" Series Test Benches provide a safe and efficient method to test hose assemblies for burst or proof testing.

CUSTOMIZED AND SPECIAL DESIGN BENCHES

In addition to the standard PCTB "Manual" series test benches, special purpose test benches can be designed by our engineering department, as well as an extension trough to meet specific requirements.

PCTB "Manual" Features

PCTB "MANUAL" SERIES

- User friendly control panel
- Full opening allows for hose assemblies to be loaded on a skid
- Built-in work light to facilitate monitoring the hose being tested
- Storage drawer to keep frequently used tools and your test bench accessories readily available



Control Panel with large dials and easy to use controls



Multi-Port Manifold Outlet allows multiple hose assemblies to be tested at the same time



Safety Switch activates and drops pressure as soon as the lid is opened



The air lubricator helps to assure the proper operation of the pump



Removable side panel permits the testing of longer hose assemblies with the attachment of an optional trough



Available extension trough in 10 foot sections

CC-FP10 Series Fitting Pusher

CC-FP10 FITTING PUSHER

- 10 ton (with 18" stroke)
- Fitting insertion on hoses up to 12 inches in diameter



TECHNICAL DATA

- **WEIGHT** 465 lbs.
- **CAPABILITY** 10 Ton (with 18" stroke)
- **DIMENSIONS** 91-½" L x 29" W x 24-¾" H

SAP #	Voltage	Phase	Plug	Hertz	Country Approved	Elbow Fitting Adapter Included	2" Strap w/Flat Hook Included	1-1/8" Wrench Included
20621100	110V	1	NEMA 5-15	60	U.S.A	✓	✓	✓
20798076	220V	1	NEMA 6-20	60	U.S.A	✓	✓	✓

EQUIPMENT



Fitting Pusher

CC-FP10 Series

CC-FP10 Series Fitting Pusher

The CC-FP10 Series fitting pusher is an essential tool for any workshop producing industrial hose assemblies.

The 10 ton hydraulic cylinder with an 18" stroke takes the time consuming and difficult task of installing industrial fittings on large hoses and makes it quick, simple, and safe. Easy portability means that you can take the CC-FP10 right to the job and quickly install fittings on hoses from 2 to 12 inches in diameter.

The CCFP-10 standard package includes: 2" strap w/ flat hook, 1-1/8" wrench, elbow fitting adapter, and pusher spacers.

CC-FP10 Features

EASY OPERATING SYSTEM

- 10 tons of available force
- Easy installing fittings on hoses from 2" to 12" in diameter
- Easy tie down and quick release system



Flexible tie down system securely grips hoses from 2 to 12 inches in diameter



Quick tightening using the wrench and quick release using the quick release pedals



10 tons of available force



Fitting pusher makes inserting industrial fittings faster and safer



Elbow fitting adapter and the ability to adjust the position of the ram makes it possible to assemble a wide variety of fittings



Quick release pedals to release the tie down straps

Hose Reel Rack Series

THE HOSE REEL RACK COMES IN 2 COMPACT MODELS

- 24" wide Hose Reel Rack
- 36" wide Hose Reel Rack

TECHNICAL DATA

- **WEIGHT** 119 lbs. (24" Hose Reel Rack)
128 lbs. (36" Hose Reel Rack)
- **HOSE CAPACITY** 600 lbs. (24" and 36" Hose Reel Racks)
- **DIMENSIONS** 36" L x 30" W x 72-½" H (24" Hose Reel Rack)
36" L x 42" W x 72-½" H (36" Hose Reel Rack)



SAP #	Hose Reel Rack Model	Powder Coat	(3) Reels Holders Included	Hardware Included
21024821	24" Wide Hose Reel Rack	Black	✓	✓
21024823	36" Wide Hose Reel Rack	Black	✓	✓

EQUIPMENT



Hose Reel Rack

Hose Reel Rack Series

Hose Reel Rack Series

The Hose Reel Rack is designed to keep hose spools organized and secure, is made of heavy-duty steel and comes in 2 compact designs (24" and 36" wide) to accommodate your needs.

Hose Reel Rack Features

KEEPING HOSE SPOOLS ORGANIZED

- 5 different positions for customizable configurations that fit various sized hose spools
- 2 reels holders for 2 larger hose spools, or 3 reels holders for 3 smaller hose spools
- 3 reels holders are included (additional reels are available)
- Easy installation, hardware included



Compact design for minimum use of space



You can customize your sized hose spools that best fits your needs



Hose reel rack keeps the hose spools organized and clean

Hose Reel Rack
Hose Reel Rack Series

EQUIPMENT
Continental

Pneumatic Trapeze Series



To know more about this new product, please contact customer service.

EQUIPMENT



Trapeze

Pneumatic Trapeze Series

Pneumatic Trapeze Series

The Pneumatic Trapeze is designed to provide a safe and efficient method to lift hoses.

Trapeze Features

ADVANTAGES

- Aids in detangling hose
- Aids in the ergonomics of pulling hose from a box
- Keeps hose straight prior to cutting
- Allows multiple boxes/reels to staged for use



Air operated system



Controller to move the arm / guide up and down



Regulated air inlet (filter/regulator)



Hose helper

CLASSIC: PC125M Series

CAPABILITY

- (-20) B2 Fittings
- (-16) SG Fittings



TECHNICAL DATA

- **CRIMPING FORCE** 60 Ton
- **WEIGHT** 72 lbs. (crimper only)
- **DIMENSIONS** 17" L x 10-1/4" W x 11" H
- **DIE SERIES** PC125



SAP #	Pump	PSI	Reservoir Capacity	Country Approved	Dies Included	Die Sizes (MM)	Quick Disconnect Included	Drawer/Stand Included
20244937	*None	N/A	N/A	Any	(8)	16, 19, 23, 27, 31, 34, 43, 50	✓	✓
20620935	*None	N/A	N/A	Any	(5)	16, 19, 23, 31, 41	✓	✓
20244894	*None	N/A	N/A	Any	None		✓	

*Do not forget to buy your pump that best fits your portable crimping requirements. See the chart below.

SAP #	Pump	PSI	Reservoir Capacity	Country Approved	Pump Model
20244931	Hand	10,000	43 in ³ (705 cc)	Any	
20244932	Pneumatic	10,000	100 cu in (1,639 cc)	Any	
20244916	110V / 3/4HP	10,000	1 Gallon	U.S.A	

CLASSIC: PC125 Series

CAPABILITY

- (-20) B2 Fittings
- (-16) SG Fittings

TECHNICAL DATA

- **CRIMPING FORCE** 60 Ton
- **WEIGHT** 140 lbs. (crimper only)
- **DIMENSIONS** 22-½" L x 13" W x 22-½" H
- **DIE SERIES** PC125
- **OIL CAPACITY** 1 gal.



SAP #	Voltage	Phase	Plug	Hertz	Country Approved	Dies Included	Die Sizes (MM)	Drawer/Stand Included
20244940	110V	1	NEMA 5-15	60	U.S.A	(8)	16, 19, 23, 27, 31, 34, 43, 50	✓
20620933	110V	1	NEMA 5-15	60	U.S.A	(5)	16, 19, 23, 31, 41	✓
20461355	240V	1		60	U.S.A	(5)	16, 19, 23, 31, 41	
20298222	110V	1	NEMA 5-15	60	Canada	(8)	16, 19, 23, 27, 31, 34, 43, 50	✓
20913958	12VDC	1	Jumper Cables	N/A	Any	(8)	16, 19, 23, 27, 31, 34, 43, 50	✓
20244938	110V	1	NEMA 5-15	60	U.S.A	None		
20244938-220	220V	1	NEMA 6-20	60	U.S.A	None		
20298169	110V	1	NEMA 5-15	60	Canada	None		

Classic Crimpers
PC125 Series

EQUIPMENT
Continental

The New CrimplIQ™ Controller Retro-Fit Kit

Are you still using a crimper with the old ACT™ Controller?

There's a better way! With our CrimplIQ™ Retro-fit kit you can upgrade your dated crimper technology to our cloud-based controller! Please contact sales for availability.



SAP #	Tablet Panel Included	PLC Included	Connection Cable Included	Bluetooth Caliper Included	1/8" Hex Key Included	(2) Test Crimp Fittings Included	(4) Front Panel Bolts Included	(6) Tablet Panel Screws Included
21043733	✓	✓	✓	✓	✓	✓	✓	✓

EQUIPMENT



CrimplIQ™ Controller Retro-Fit Kit

PC200 and PC400 Series

The New CrimplIQ™ Controller Retro-Fit Kit

Continental introduces the new CrimplIQ™ Controller Retro-Fit Kit for the PC200 and PC400 Crimpers. Upgrade your PC200/PC400 crimper with the new CrimplIQ™ Controller and discover the crimping technology at your fingertips. The CrimplIQ™ Controller software is cloud-based and can provide instant information to owners. Wi-Fi is required. The CrimplIQ™ Controller Retro-Fit Kit standard package includes: Tablet panel, PLC, connection cable, bluetooth caliper, 1/8" hex key, test crimp hose assembly, (4) front panel bolts, and (6) tablet panel screws.

CrimplIQ™ Controller Features

FUNCTIONALITY

- Easy to use interface, on a 10-inch color capacitive touch screen
- Daily reports*
- Remote downloading of updated crimp specifications*
- Favorite thousands of crimp details
- Security - end-to-end data encryption from tablet to cloud
- Operators only have access to essential crimp applications

OPERATIONALITY

- Bluetooth calipers provided with each crimper
- User accounts track operations to individual team members
- Remote troubleshooting*
- In-depth training and tutorial guides
- Video support*

LONGEVITY

- Preventative maintenance alerts
- Full controller backup to the cloud*
- Future enhancements through cloud updates*

***Needs connection to Wi-Fi**



Continental CrimplIQ™ controller, the future of crimping at your fingertips



10-inch color capacitive touch screen and user friendly navigation



Intuitive screens lead the operator through the setup and crimping process



CrimplIQ™ controller supports bluetooth calipers to input crimp diameter measurements



CrimplIQ™ Controller Retro-Fit Kit
PC200 and PC400 Series

EQUIPMENT
Continental

Continental Bluetooth/Standard/Notched Calipers

Caliper Features

- Bluetooth caliper: The CrimpIQ™ controller supports bluetooth caliper to input crimp diameter measurements. This integration saves time and reduces the chance that measurements are incorrectly entered.
- Standard caliper: Has a long smooth surface great for larger crimp flats.
- Notched caliper: Is great for measuring small crimp flats and AC style crimps.

Part #	Description
21021158	Continental Bluetooth Digital Caliper (IN/MM) (only compatible with CrimpIQ™ Controller)
20926932	Continental Standard Digital Caliper (IN/MM)
20926931	Continental Notched Digital Caliper (IN/MM)



Bluetooth Caliper































Standard Caliper



Notched Caliper

Crimper Replacement Kits

SAP# 21053593					
<ul style="list-style-type: none"> PC125RCD-SPK includes: Quantity 	(2) 4oz Bottles of CrimpX Oil	(1) Die Removal Magnet	(1) Continental Caliper		
SAP# 21053592					
<ul style="list-style-type: none"> PC125-SPK includes: Quantity 	(2) 4oz Bottles of CrimpX Oil	(1) PC125 Black Die Ring (Half)	(8) PC125 Die Screws	(8) PC125 Die Springs	
SAP# 21053594					
<ul style="list-style-type: none"> PC150-SPK includes: Quantity 	(2) 4oz Cans of CrimpX Grease	(1) PC150 Black Die Ring (Half)	(8) PC150 Die Screws	(8) PC150 Die Springs	
SAP# 21053595					
<ul style="list-style-type: none"> PC150H-SPK includes: Quantity 	(1) 3oz Mini Gun Tube of CrimpX Grease	(4) PC150H Foam Pads	(8) PC150H Die Studs	(8) QCT Pins	
SAP# 21099232					
<ul style="list-style-type: none"> PC150HD-SPK includes: Quantity 	(1) 14oz Large Tube of CrimpX Grease	(4) PC150HD Foam Pads	(8) PC200 Die Studs	(8) QCT Pins	
SAP# 21053596					
<ul style="list-style-type: none"> PC200-SPK includes: Quantity 	(1) 14oz Large Tube of CrimpX Grease	(4) PC200 Foam Pads	(8) PC200 Die Studs	(8) QCT Pins	
SAP# 21053597					
<ul style="list-style-type: none"> PC400-SPK includes: Quantity 	(1) 14oz Large Tube of CrimpX Grease	(4) PC400 Foam Pads	(8) PC200 Die Studs	(4) PC400 Die Studs	(8) QCT Pins

Crimper Replacement Kits

PC125RCD/125/150/150H/150HD/200/400 Series

EQUIPMENT



PC125 Dies

Compatible with: PC125M & PC125

Part #	Description	Color	ID
20244896	PC125-8.5MM	Black	8.5 mm
20244897	PC125-12MM	Black	12 mm
20244898	PC125-14MM	Red	14 mm
20244899	PC125-16MM	Blue	16 mm
20244920	PC125-19MM	Green	19 mm
20244921	PC125-23MM	Yellow	23 mm
20244922	PC125-27MM	Brown	27 mm
20244923	PC125-31MM	Silver	31 mm
20244924	PC125-34MM	Purple	34 mm
20244925	PC125-41MM	Orange	41 mm
20867524	PC125-43MM	Black	43 mm
20244927	PC125-50MM	Black	50 mm



PC125 Die Screw
P/N: 20244928



PC125 Die Spring
P/N: 20244929

Part #	Description	Color	Etch
21095958	PC125 Die Ring Half	Black	P125-8.5
21095957	PC125 Die Ring Half	Black	PC125-12
20370767	PC125 Die Ring Half	Red	PC125-14
20370760	PC125 Die Ring Half	Blue	PC125-16
20370748	PC125 Die Ring Half	Green	PC125-19
20370772	PC125 Die Ring Half	Yellow	PC125-23
20370761	PC125 Die Ring Half	Brown	PC125-27
20370762	PC125 Die Ring Half	Silver	PC125-31
20370763	PC125 Die Ring Half	Purple	PC125-34
20370765	PC125 Die Ring Half	Orange	PC125-41
20918174	PC125 Die Ring Half	Red	PC125-43L
20918175	PC125 Die Ring Half	Black	PC125-45
20918176	PC125 Die Ring Half	Black	PC125-50
20370778	PC125 Die Ring Half	Black	None



PC125 Die Ring Half

Yellow Decal

Etch

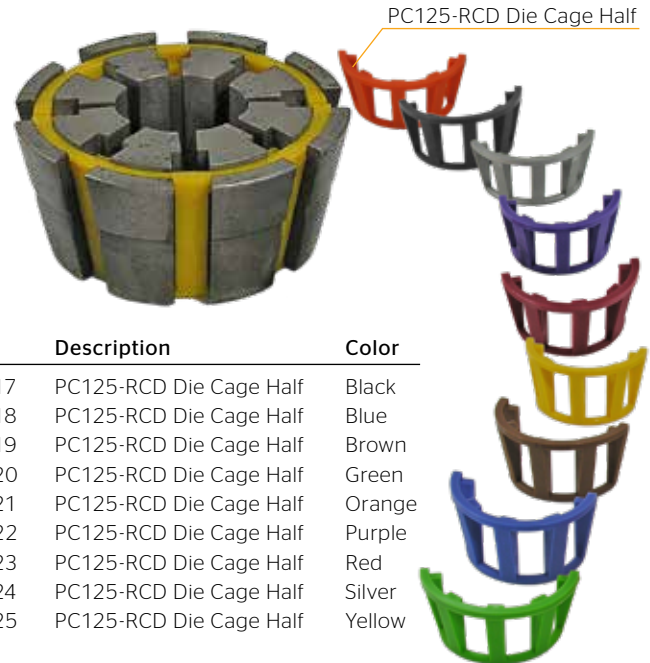

PC125-RCD Die Cage Half

PC125RCD Dies

Compatible with: PC100-RCD Series,
PC125M-RCD, PC125-RCD, & PC125PS

Part #	Description	Color	ID
20809576	PC125RCD-16MM	Blue	16 mm
20809577	PC125RCD-19MM	Green	19 mm
20809578	PC125RCD-23MM	Yellow	23 mm
20809579	PC125RCD-27MM	Brown	27 mm
20809760	PC125RCD-31MM	Silver	31 mm
20809761	PC125RCD-34MM	Purple	34 mm
20809762	PC125RCD-41MM	Orange	41 mm
20899115	PC125RCD-43MM	Red	43 mm
20833014	PC125RCD-50MM	Black	50 mm

Part #	Description	Color
20833017	PC125-RCD Die Cage Half	Black
20833018	PC125-RCD Die Cage Half	Blue
20833019	PC125-RCD Die Cage Half	Brown
20833020	PC125-RCD Die Cage Half	Green
20833021	PC125-RCD Die Cage Half	Orange
20833022	PC125-RCD Die Cage Half	Purple
20833023	PC125-RCD Die Cage Half	Red
20833024	PC125-RCD Die Cage Half	Silver
20833025	PC125-RCD Die Cage Half	Yellow

PC150 Dies

Compatible with: PC150

Part #	Description	Color	ID
20244949	PC150-8.5MM	Black	8.5 mm
20244950	PC150-12MM	Black	12 mm
20244951	PC150-14MM	Red	14 mm
20244952	PC150-16MM	Blue	16 mm
20244953	PC150-19MM	Green	19 mm
20244954	PC150-23MM	Yellow	23 mm
20244955	PC150-27MM	Brown	27 mm
20244956	PC150-31MM	Silver	31 mm
20244957	PC150-34MM	Purple	34 mm
20244958	PC150-41MM	Orange	41 mm
20244959	PC150-45MM	Black	45 mm
20244960	PC150-50MM	Black	50 mm
20244961	PC150-56MM	Black	56 mm



PC150 Die Screw
P/N: 20244962



PC150 Die Spring
P/N: 20244963

Part #	Description	Color	Etch
21095962	PC150 Die Ring Half	Black	PC150-8.5
21095959	PC150 Die Ring Half	Black	PC150-12
20688964	PC150 Die Ring Half	Blue	PC150-16
20704273	PC150 Die Ring Half	Green	PC150-19
20704275	PC150 Die Ring Half	Yellow	PC150-23
20455159	PC150 Die Ring Half	Brown	PC150-27
20543412	PC150 Die Ring Half	Silver	PC150-31
20466009	PC150 Die Ring Half	Purple	PC150-34
20495092	PC150 Die Ring Half	Orange	PC150-41
21095960	PC150 Die Ring Half	Black	PC150-45
20646846	PC150 Die Ring Half	Black	PC150-50
21095961	PC150 Die Ring Half	Black	PC150-56



PC150 Double Angle Dies

Compatible with: PC150

Part #	Description	Color	ID
20294365	49MM X 85MM	Black	49 mm
20294366	53MM X 108MM	Black	53 mm
20294367	58MM X 108MM	Black	58 mm
20294368	62MM X 108MM	Black	62 mm
20294369	69MM X 85MM	Black	69 mm
20294480	74MM X 108MM	Black	74 mm
20294481	78MM X 108MM	Black	78 mm
20951074	52MM X 108MM	Black	52 mm
21061269	56MM X 108MM	Black	56 mm



PC150 DA Die Screw
P/N: 21095557



PC150/PC150 DA Die Spring
P/N: 20244963

Dies

PC150/PC150 DA Series

EQUIPMENT



PC150H Dies

Compatible with: PC150H &
PC150HD

Part #	Description	Color	ID
20316414	PC150H-8.5	Black	8.5 mm
20316415	PC150H-12	Black	12 mm
20316416	PC150H-14	Red	14mm
20316417	PC150H-16	Blue	16 mm
20316418	PC150H-19	Green	19 mm
20316419	PC150H-23	Yellow	23 mm
20316420	PC150H-27	Brown	27 mm
20316421	PC150H-31	Silver	31 mm
20316422	PC150H-34	Purple	34 mm
20316423	PC150H-41	Orange	41 mm
20316424	PC150H-45	Black	45 mm
20316425	PC150H-50	Black	50 mm
20644520	PC150H-53	Black	53 mm
20316426	PC150H-56	Black	56 mm



PC200 Die Lock Stud
P/N: 20269407

PC200 Dies

Compatible with: PC200, PC200i,
PC400, PC400i, PC440, PC440i,
PC600L, PC600i, PC1000, PC1000i,
PC1200, & PC1200i

Part #	Description	Color	ID
20244973	PC200-8.5MM	Black	8.5 mm
20244974	PC200-12MM	Black	12 mm
20244975	PC200-14MM	Red	14 mm
20244976	PC200-16MM	Blue	16 mm
20244977	PC200-19MM	Green	19 mm
20244978	PC200-23MM	Yellow	23 mm
20244979	PC200-27MM	Brown	27 mm
20244980	PC200-31MM	Silver	31 mm
20244981	PC200-34MM	Purple	34 mm
20244982	PC200-41MM	Orange	41 mm
20244983	PC200-45MM	Black	45 mm
20244984	PC200-50MM	Black	50 mm
20646528	PC200-53MM	Black	53 mm
20244985	PC200-56MM	Black	56 mm
20244986	PC200-62MM	White	62 mm
20244987	PC200-69MM	Pink	69 mm
20244988	PC200-74MM	Lime	74 mm
20249890	PC200-78MM	Orange	78 mm



PC200 Die Lock Stud
P/N: 20269407

PC600i Dies

Compatible with: PC440, PC440i, PC600L & PC600Li

Part #	Description	ID
20673573	PC600-84MM	84 mm
20685703	PC600-86MM	86 mm
20742520	PC600-89MM	89 mm
20685704	PC600-90MM	90 mm
20673574	PC600-92MM	92 mm
20673575	PC600-100MM	100 mm
20673576	PC600-108MM	108 mm
20802397	PC600-114MM	114 mm
20673577	PC600-116MM	116 mm
20685705	PC600-118MM	118 mm
20258403	PC600-122MM	122 mm
20673578	PC600-126MM	126 mm
20562654	PC600-166MM	166 mm
20562655	PC600-178MM	178 mm



PC200 Die Lock Stud
P/N: 20269407



PC440/PC600/PC600L/PC1000
Master Die Lock Stud
P/N: 20776806

PC1000i Dies

Compatible with: PC600, PC600i, PC1000 & PC1000i

Part #	Description	ID
20562098	PC600-84MM	84 mm
20562099	PC600-92MM	92 mm
20562650	PC600-100MM	100 mm
20562651	PC600-108MM	108 mm
20562652	PC600-116MM	116 mm
20562653	PC600-126MM	126 mm



PC200 Die Lock Stud
P/N: 20269407



PC1000
Master Die Lock Stud
P/N: 20776808

Compatible with: PC1000 & PC1000i

Part #	Description	ID
20590712	PC1000-166MM	166 mm
20590713	PC1000-178MM	178 mm
20708157	PC1000-190MM	190 mm
20590714	PC1000-215MM	215 mm
20590715	PC1000-245MM	245 mm



PC440/PC600/PC600L/PC1000
Master Die Lock Stud
P/N: 20776806



PC1000
Master Die Lock Stud
P/N: 20776807

Dies

PC600i/PC1000i Series

EQUIPMENT



PC1200i Dies

Compatible with: PC1200i

Part #	Description	ID
20818690	PC1200-155MM	155 mm
20828458	PC1200-166MM	166 mm
20828459	PC1200-178MM	178 mm
20775367	PC1200-245MM	245 mm
20818691	PC1200-260MM	260 mm
20828650	PC1200-275MM	275 mm
20775368	PC1200-281MM	281 mm



PC200 Die Lock Stud
P/N: 20269407



PC1200i Die Lock Pin For Adapter Dies
& Industrial Dies Series P/N: 21099179



PC1200i Die Lock Pin For Adapter Dies
& Industrial Dies Series P/N: 21099230

PC125-AC Dies

Compatible with: PC125M & PC125

Part #	Description	Color	ID
20341146	PC125-AC06	Black	.551 in
20341147	PC125-AC08	Black	.728 in
20341148	PC125-AC12	Black	.885 in



PC125RCD-AC Dies

Compatible with: PC100-RCD Series,
PC125M-RCD, PC125-RCD, & PC125PS

Part #	Description	Color	ID
20833026	PC125RCD-AC06	Orange	.551 in
20833027	PC125RCD-AC08	Orange	.728 in
20833028	PC125RCD-AC12	Orange	.880 in



PC150-AC Dies

Compatible with: PC150

Part #	Description	Color	ID
20341547	PC150-AC06	Black	.551 in
20341548	PC150-AC08	Black	.728 in
20341549	PC150-AC12	Black	.885 in



PC150H-AC Dies

Compatible with: PC150H & PC150HD

Part #	Description	Color	ID
20345080	PC150H-AC06	None	.551 in
20345081	PC150H-AC08	None	.728 in
20345082	PC150H-AC12	None	.885 in



PC200-AC Dies

Compatible with: PC200, PC200i,
PC400, PC400i, PC440, PC440i,
PC600L, PC600i, PC1000, PC1000i,
PC1200, & PC1200i

Part #	Description	Color	ID
20825493	PC200-AC04	None	.472 in
20345083	PC200-AC06	None	.551 in
20345084	PC200-AC08	None	.728 in
20345085	PC200-AC12	None	.885 in



PC150H & PC200 Die Series Decals



8.5 mm Black
8 Piece Die Decal
P/N: 20922986



12 mm Black
8 Piece Die Decal
P/N: 20922960



14 mm Red
8 Piece Die Decal
P/N: 20922961



16 mm Blue
8 Piece Die Decal
P/N: 20922962



19 mm Green
8 Piece Die Decal
P/N: 20922963



23 mm Yellow
8 Piece Die Decal
P/N: 20922964



27 mm Brown
8 Piece Die Decal
P/N: 20922965



31 mm Silver
8 Piece Die Decal
P/N: 20922966



34 mm Purple
8 Piece Die Decal
P/N: 20922967



39 mm Orange
8 Piece Die Decal
P/N: 21095963



41 mm Orange
8 Piece Die Decal
P/N: 20922968



45 mm Black
8 Piece Die Decal
P/N: 20922969

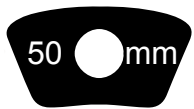

50 mm Black
8 Piece Die Decal
P/N: 20922980



56 mm Black
8 Piece Die Decal
P/N: 20922981



57 mm Black
8 Piece Die Decal
P/N: 21095964



59 mm Black
8 Piece Die Decal
P/N: 21095965

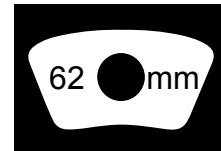

62 mm White
8 Piece Die Decal
P/N: 20922982



63 mm White
8 Piece Die Decal
P/N: 21095966



69 mm Pink
8 Piece Die Decal
P/N: 20922983



74 mm Lime
8 Piece Die Decal
P/N: 20922984



78 mm Orange
8 Piece Die Decal
P/N: 20922985

PC150H & PC200 Die Series Die Decal Kit

SAP# 20923531

- This PC150H die decal kit includes (8) pieces die decal of each of the following die sizes 16mm, 19mm, 23mm, 27mm, 31mm, 34mm, 41mm, 45mm, 50mm, 53mm, 59mm, 62mm, 74mm, 78mm plus (8) PC200 die studs.



Replacement Parts

Removable Pushers



PC100 Pusher
Removable Pusher with Magnets
P/N: 20244918
Removable Pusher without Magnets
P/N: 20244933



PC100RCD/PC125 Pusher
Removable Pusher with Magnets
P/N: 20348434
Removable Pusher without Magnets
P/N: 20551881



PC150 Pusher
Removable Pusher without Magnets
P/N: 20244946

Pressure Plates



PC100 Series
Pressure Plate
P/N: 20244935



PC125 Series
Pressure Plate
P/N: 20395217



PC150 Series
Pressure Plate
P/N: 20244948



PC150 Series
Double Angle Base
P/N: 20294363



PC150 Spacer Kit
for use with extra
long elbow fittings
P/N: 20244965

T420 Pressure Plates



PC100RCD Series
T420 Pressure Plate
P/N: 21095967



PC100RCD Series
T420 Notched Pressure Plate
P/N: 21095968



PC125RCD Series
T420 Pressure Plate
P/N: 20833015



PC125RCD Series
T420 Notched Pressure Plate
P/N: 20867520



PC125PS Series
Pressure Plate
P/N: 20495499



PC125PS Series
Notched Pressure Plate
P/N: 20548179

Compression Rings



PC100 Series
Compression Ring
P/N: 20244934



PC100 Series
Notched Compression Ring
P/N: 20348935



PC125 Series
Compression Ring
P/N: 20470304



PC125 Series
Notched Pressure Plate
P/N: 20348513



PC150 Series
Compression Ring
P/N: 20244947



PC150 Series
Double Angle Top
P/N: 20294364

Replacement Parts

Die Storage Shelves / Racks



PC125 Stand / Drawer
P/N: 20244895



PC150 Die Shelf
P/N: 20244943



PC150H Die Rack 9 Stations
84mm Die Series P/N: 20316458
99mm Die Series P/N: 20406017



PC200 Rack Stand 16 Stations
99mm Die Series P/N: 20244970



Industrial Die Compartment
P/N: 21095971

Die Lubricant



Mini Grease Gun w/ CRIMPX Die
Lubricant 3 oz mini grease tube
P/N: 21095969



14 oz Grease Gun w/ CRIMPX Die
Lubricant 14 oz large grease tube
P/N: 21095970



CRIMPX Die Lubricant
3 oz mini grease tube
P/N: 20244993



CRIMPX Die Lubricant
14 oz large grease tube
P/N: 20828391



CRIMPX Lubricant Grease
4 oz can with brush
P/N: 20828390



CRIMPX Lubricant Grease
16 oz can with brush
P/N: 20244994



CRIMPX Die Lubricant Oil:
4 oz bottle with dauber cap
P/N: 20708983



PC900 Aerosol Lube
Dry-Moly
P/N: 20244995

Replacement Parts

Die Removal Tools



Die Removal Magnet
PC100/PC125/PC150
P/N: 20934196



Quick Change Tool
84mm Die Series P/N: 20319405
99mm Die Series P/N: 20267266



Intermediate Die Removal Tool
PC200i/PC400i
P/N: 20415012



Intermediate Die Removal T-Handle Hex
PC440i/PC600i/PC1000i/PC1200i
P/N: 21095975

Foot Switches



Foot Switch w/ Guard
Touch Screen Crimpers
P/N: 21095974



Foot Switch w/ Guard
Dial Micrometer Crimpers
P/N: 21095973



Foot Switch Only
Touch Screen Crimpers
P/N: 20553044



Start / Stop Switch
1-2 HP Pumps
P/N: 20244945

Adjustable Coupling Stops & Manual / Electric Back Stops



PC125 Coupling Stop
P/N: 20244936



PC150 Coupling Stop
P/N: 20244944



PC150H Manual Back Stop
P/N: 21095976



PC200-MBS Manual Back Stop
P/N: 20244971



PC200-EBS Electric Back Stop
P/N: 20244972

PSW101 Spacer Rings



PSW101-0 Spacer
P/N: 20524128

PSW101-1 Spacer
P/N: 20495500

PSW101-2 Spacer
P/N: 20495501

PSW101-3 Spacer
P/N: 20495502

PSW101-4 Spacer
P/N: 20495503

PSW101-5 Spacer
P/N: 20495504

PSW101-6 Spacer
P/N: 20495505

PSW101-8 Spacer
P/N: 20559204

PSW101-9 Spacer
P/N: 20902035

PSW101-10 Spacer
P/N: 20902036

PSW101-11 Spacer
P/N: 20902037

Replacement Parts

Micrometers



T420 Micrometer
PC100/PC125
P/N: 20833016



Metric Micrometer
PC100/PC125/PC150
P/N: 20370791



Dial Micrometer
PC150H P/N: 20628361
PC150HD P/N: 21095977
PC200M P/N: 21095978

Protective Master Die Foam Pads



Protective Master Die Foam Pad
PC150H P/N: 20419636



Protective Master Die Foam Pad
PC150HD P/N: 21095979



Protective Master Die Foam Pad
PC200 P/N: 20419635



Protective Master Die Foam Pad
PC400 P/N: 20419639

Die Springs / Screws



PC125 Die Spring
P/N: 20244929



PC125 Die Screw
P/N: 20244928



PC150/PC150 DA Die Spring
P/N: 20244963



PC150 Die Screw
P/N: 20244962



PC150 DA Die Screw
P/N: 21095557

Die Lock Studs



PC200 Die Lock Stud
P/N: 20269407



PC400 Die Lock Stud
P/N: 20276754



PC440 Die Lock Stud
P/N: 21038385



PC1200i Die Lock Stud
P/N: 21099179



PC1200i Die Lock Stud
P/N: 21099230

Replacement Parts

Master Die Lock Studs



PC1000 Master Die Lock Stud
P/N: 20776808



PC440/PC600/PC600L/PC1000
Master Die Lock Stud
P/N: 20776806



PC1000 Master Die Lock Stud
P/N: 20776807

Hose Saw Blades & Accessories



Serrated Blade
HS-150 P/N: 20683699
HS-500 P/N: 20922988



Scalloped Blade
HS-150 P/N: 21095980
HS-500 P/N: 20683700

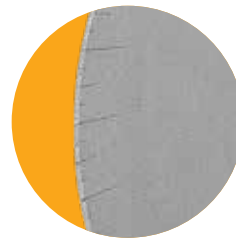

Double Bevel w/SS Slots Blade
HS-150 P/N: 20804794
HS-500 P/N: 21095981



HS-500 Mobile Cart
HS-500 P/N: 21095982



Hose Helper
HS-500 P/N: 21095983



Mister Hose Assembly
HS-500 P/N: 21095984



Hose Channel System (5ft)
HS-500 P/N: 21095985



Hose Bending Pins
HS-150/HS-500 P/N: 21095986

SM300 / SM300M ID & OD Skiving Tools & Accessories



OD Skiving Tool Assembly

3/16"	P/N: 21021137	1"	P/N: 21021143
1/4"	P/N: 21021138	1-1/4"	P/N: 20687014
1/2"	P/N: 21021140	1-1/2"	P/N: 20687016
3/4"	P/N: 21021142	2"	P/N: 20687017
3/8"	P/N: 21021139	2-1/2"	P/N: 21021144
5/8"	P/N: 21021141	3"	P/N: 21021145



ID Skiving Tool Assembly

0.375"	P/N: 21021130
0.500"	P/N: 21021131
0.625"	P/N: 21021132
0.750"	P/N: 21021133
1"	P/N: 21021134
1-1/4"	P/N: 20687018
1-1/2"	P/N: 20687019
2"	P/N: 20687020
2-1/2"	P/N: 21021135
3"	P/N: 21021136



Skiving Tool Insert
P/N: 21021147
Skiving Tool Insert Screw
P/N: 21021148

Replacement Parts

CrimplQ™ Controller



CrimplQ™ 10 inch tablet
P/N: 21021149



CrimplQ™ Caliper Dongle
P/N: 21021153

Hand/Pneumatic/Electric Pumps



PC100 Hand Pump
P/N: 21095988



PC125-HPump Hand Pump
PC125M P/N: 20244931



PC125-PPump Pneumatic Pump
PC100/125M P/N: 20244932



PC125M Portable Power Unit
110V / 3/4HP
P/N: 20244916

Electrical Plug Configuration Equipment

Crimper Power Cord - Plug Ends / Electrical Receptacle Outlet Requirements

The following Crimper Cords are supplied as standard with the purchase of the associated Crimper Voltage - Phase combination from Continental.

U.S.A

**110V 15A Grounding Plug
(NEMA 5-15)**



U.S.A

**220V 20A 1PH Grounding Plug
(NEMA 6-20)**



U.S.A

**30A 250V 1PH Grounding Plug
(NEMA L6-30P)**



U.S.A

**20A 250V 3PH Grounding Plug
(NEMA L15-20P)**



U.S.A

**20A 480V 3PH Grounding Plug
(NEMA L1620P)**



CANADA

**30A 250V 3PH Grounding Plug
(NEMA L1530P)**



Preventative Maintenance Package Crimpers

Continental's preventative maintenance program for PC200/400/440/600/600L/1000 series crimpers is an annual service which keeps your crimper cleaned, calibrated, and running in peak performance. This service includes the cleaning of main wear components, inspection of wear components and seals, and calibration of your crimper. Prevent downtime with this economical service package performed at your facility.

We hope that our services will help eliminate downtime, shipping costs, and uncertainty of when your machine will be fixed. Please feel free to contact us to know more about the preventative maintenance package for your crimper.

Inspection of Potentiometer Bracket Assembly

New Grease Applied on All Wear Surfaces

Available CrimpIQ™ Controller Upgrade

Crimper Calibration

Inspection of Electrical Components

EQUIPMENT



Preventative Maintenance Package

PC200/400/440/600/600L/1000 Series Crimpers

Crimper Calibration Services

Continental realizes how important crimper calibration is to your customer requirements. We offer yearly onsite calibration services to your crimping equipment for a nominal fee. Make sure you are compliant with your customers' standards and schedule your crimper calibration today.



		Continental Crimper Calibration	
1. Place the adapter die set in 1 thru 8 clockwise order.			
2. Place the calibration die set into the adapter dies in 1 thru 8 clockwise order.			
3. Perform onsite calibration of callipers with gage pins.			
Gage Pin Diameter	0.496" x _____	Gage Pin Diameter	0.577" x _____
Pre-Calibration Center Crimp Details			
Wire Crimp Diameter	_____ inches x _____ mm		

Industrial Fluid Solutions

Market segment

Hydraulic Hose

Contact

Continental

703 S. Cleveland Massillon Road

Fairlawn, OH 44333-3023 U.S.A.

1-800-235-4632

www.continental-industry.com

Your local contact

www.contitech.de/contactlocator

Canada

1-888-275-4397

Mexico

1-800-439-7373



The content of this publication is not legally binding and is provided as information only. The trademarks displayed in this publication are the property of Continental AG and/or its affiliates. Copyright © 2021 ContiTech AG. All rights reserved. For complete information go to: www.contitech.de/disc_en